

**SUPEROFFERTA**  
2024



# NON BESTEMMIARE



**USAG XGRIP**

**Utensili per dadi e viti spanati.**

**€ Senza IVA 64/2024**

Valida fino al 31/01/2025

<b>0</b>		235 3/4" M/C8 Pag. 90	333 K/SH8 Pag. 41	516 ST6NPM Pag. 20	519 R807/3V Pag. 25	871 C Pag. 81
001 RV Pag. 37	236 K Pag. 91	367 SE6 Pag. 71	516 ST6NV Pag. 18	519 R808/3V Pag. 25	871 D Pag. 81	
001 TRV Pag. 37	236 KE Pag. 91	376 Pag. 71	516 ST6PA Pag. 20	519 R96/3MA Pag. 26	884 C/56 Pag. 83	
002 JMA Pag. 32	236 KE/C22 Pag. 91	382 Pag. 71	516 ST6PM Pag. 20	519 R96/3MM Pag. 26	885 F Pag. 83	
002 JMA Pag. 32	237 1/2" AK Pag. 59	382 F Pag. 71	516 ST6V Pag. 18	519 R96/3NMA Pag. 26	889 GR Pag. 74	
002 UDE Pag. 33	237 1/4" AK Pag. 59	391 Pag. 82	516 ST7NV Pag. 18	519 R96/3NMM Pag. 26	889 IL Pag. 74	
002 UDM Pag. 33	<b>237 1/4" SK Pag. 60</b>		516 ST7V Pag. 18	519 R96/3NV Pag. 24	889 RL Pag. 74	
007 IV Pag. 34	252 N/SR8 Pag. 55	<b>400</b>		519 R96/3V Pag. 24	889 RP Pag. 75	
007 FLV Pag. 35	263/S16 Pag. 61	400 P Pag. 82	516 ST8V Pag. 19	519 R96/4MM Pag. 27	889 RT Pag. 75	
007 MCV Pag. 35	270 C/C3 Pag. 79	421 M Pag. 77	516 ST8V Pag. 19	519 R96/4NMM Pag. 27	<b>889 SP Pag. 75</b>	
007 MLV Pag. 67	272 OS Pag. 79	421 P Pag. 77	<b>516 STS7NV Pag. 19</b>	519 R96/4NV Pag. 25	890 K Pag. 77	
007 MV Pag. 67	276 CE/SE8 Pag. 55	426 B/S5 Pag. 82	<b>516 STS7V Pag. 19</b>	519 R96/4V Pag. 25		
007 PLV Pag. 35	280 HAP/SE6 Pag. 43	426 C/S4 Pag. 82	516 STXL6MM Pag. 22	519 R57/3V Pag. 24	<b>800</b>	
007 RV Pag. 36	280 HATX/SE6 Pag. 43	426 D/S4 Pag. 82	516 STXL6NV Pag. 19	519 RS7/5V Pag. 25	910 E1 1" Pag. 87	
007 SV Pag. 36	280 HQ/SE6 Pag. 43	<b>442 TA Pag. 70</b>	516 STXL6V Pag. 19	519 RS8/3V Pag. 24	913 PC2 1/2" Pag. 88	
007 TV Pag. 36	280 HOTS/SE6 Pag. 43	443 N Pag. 80	519/127N Pag. 30	519 RSC4/3V Pag. 25	920 AM1 Pag. 88	
007 TVX Pag. 34	<b>280 HX/SE6 Pag. 8</b>	446 DA/SE6 Pag. 80	519/150AX Pag. 30	519 RSC4/4V Pag. 25	921 A4 Pag. 88	
007 V Pag. 34	280 LTS/S9 Pag. 45	446 DT/S2 Pag. 81	519/276 Pag. 30	519 RSC4/5V Pag. 25	922 B1 Pag. 89	
063 W Pag. 66	280 LTSTX/S8 Pag. 45	446 S28 Pag. 80	519/280HG Pag. 30		922 BL1 Pag. 89	
074 A Pag. 67	280 TK/SE6 Pag. 42	447 T Pag. 76	519/280HOTS Pag. 30	<b>600</b>		
085 EX/SE3 Pag. 46	280 TQ Pag. 41	451 N/S4 Pag. 61	519/280T Pag. 30	601 1/2" J22 Pag. 56	922 BP1 Pag. 89	
091 D/SH5 Pag. 40	280 T/SE7 Pag. 42	454 Pag. 61	519/285A1 Pag. 30	601 1/4-1/2" J82 Pag. 57	928 AC1 1/2" Pag. 86	
091 SH5 Pag. 40	280 TTS/SE6 Pag. 42	458 S6 Pag. 61	519/285B2 Pag. 30	601 1/4-1/2" J100 Pag. 57	928 D1 3/4" Pag. 86	
091 SH8 Pag. 40	280 TTX/SE8 Pag. 42	458 S20 Pag. 61	519/285KA1 Pag. 30	601 1/4-1/2" JTX16 Pag. 56	929 PC1 1/2" Pag. 84	
	280 XLTS/S9 Pag. 45	495 MAA Pag. 28	519/294 Pag. 30	601 1/4" J34 Pag. 56	929 PC1/C12 Pag. 85	
	<b>280 X/S9 Pag. 8</b>	495 MB Pag. 28	519/322H Pag. 30	606 1/2" EA Pag. 58	939 C1 Pag. 88	
	282 S10 Pag. 72	495 MC Pag. 28	519/322STX Pag. 30	606 1/4" EA Pag. 58	942 PC3 1/2" Pag. 84	
	285 DS8 Pag. 54	495 PA Pag. 29	519/324H Pag. 30	606 1/4" SK Pag. 60	942 PC3/C7 Pag. 85	
	285 DS12 Pag. 54	495 PM Pag. 29	519/324TX Pag. 30	609 1/4" EB Pag. 59	942 PD1 3/4" Pag. 86	
	285 J/DS7 Pag. 55	<b>500</b>		<b>609 1/4" SKX Pag. 7</b>	942 PE1 1" Pag. 87	
	285 J/DS12 Pag. 55	501 P Pag. 16	519/366 Pag. 30	610 1/4" EFK Pag. 60	943 PC1 1/2" Pag. 84	
	285 KA/DS8 Pag. 52	<b>504 SN Pag. 23</b>	519/382F Pag. 30	612 3/4" B Pag. 59	943 PC1/C12 Pag. 85	
	285 KA/DS12 Pag. 52	<b>504 SNA Pag. 23</b>	519/613AEA Pag. 30	612 3/4" EB Pag. 59	943 PC2 1/2" Pag. 86	
	285 KB/DS7 Pag. 53	<b>504 SR Pag. 23</b>	519/6138EA Pag. 30	640 A Pag. 37	988 D/S3 Pag. 73	
	285 KB/DS12 Pag. 53	<b>506 KA Pag. 15</b>	519/613CEA Pag. 30	641 T Pag. 37	988 E/S10 Pag. 73	
	285 KF/DS8 Pag. 53	<b>506 KL Pag. 15</b>	519/990A1 Pag. 30	646/5LV Pag. 37	988 G/S12 Pag. 73	
	285 KF/SE5 Pag. 53	<b>506 TA Pag. 17</b>	519 M 091A Pag. 31	<b>660 X/B9 Pag. 7</b>	988 LA/S14 Pag. 73	
	285 P/SE5 Pag. 54	<b>506 TAC Pag. 16</b>	519 M 127N Pag. 31	664 B/S7 Pag. 44	988 MA/S19 Pag. 73	
	285 SE26 Pag. 54	<b>506 TC Pag. 17</b>	519 M 150AX Pag. 31	664 S25 Pag. 44	988 MA/S25 Pag. 73	
	285 X/B8 Pag. 5	<b>506 TL Pag. 17</b>	<b>519 M 235X Pag. 9</b>	687 1/2" C16 Pag. 90	995 A Pag. 69	
	285 X/B12 Pag. 5	<b>506 TLC Pag. 16</b>	519 M 276 Pag. 31	688 3/4" MD6 Pag. 90	995 AF Pag. 69	
	294 AC Pag. 51	<b>516 SA/BCA Pag. 13</b>	519 M 280HG Pag. 31	692 J32 Pag. 44	995 CA Pag. 69	
	294 AD Pag. 51	<b>516 SA/BCL Pag. 13</b>	519 M 280HGTS Pag. 31	692 J49 Pag. 44	995 LA Pag. 69	
	294 AG Pag. 51	<b>516 SA/CA Pag. 13</b>	<b>519 M 280HX Pag. 9</b>	692 J100 Pag. 45	997 A Pag. 72	
		<b>516 SA/CBA Pag. 11</b>	519 M 280N1 Pag. 31		997 B Pag. 72	
		<b>516 SA/CBL Pag. 11</b>	519 M 280T Pag. 31	<b>700</b>		
		<b>516 SA/CL Pag. 13</b>	519 M 280TK Pag. 31	753 A Pag. 66	<b>1000</b>	
		<b>516 SA/CTA Pag. 11</b>	519 M 285A1 Pag. 31	753 KA Pag. 66	1613 AGM12-24 Pag. 76	
		<b>516 SA/CTL Pag. 11</b>	519 M 285A2 Pag. 31		1613 RA12 Pag. 76	
		<b>516 SA/PRA Pag. 12</b>	519 M 285KA Pag. 31	<b>800</b>		
		<b>516 SA/PRL Pag. 12</b>	519 M 285KB Pag. 31	810 N Pag. 64	1651 Pag. 77	
		<b>516 SA/STA Pag. 12</b>	<b>519 M 285X Pag. 9</b>	810 SA Pag. 63	1785 B Pag. 77	
		<b>516 SA/STL Pag. 12</b>	519 M 294B Pag. 31	811 LB Pag. 62	1881 S22 Pag. 81	
		516 ST5V Pag. 18	519 M 324H Pag. 31	811 LBE Pag. 62	1950 C Pag. 78	
		516 ST6MA Pag. 21	519 M 324STX Pag. 31	811 NE Pag. 64	<b>2000</b>	
		516 ST6MM Pag. 21	519 M 382F Pag. 31	811 SE Pag. 63	2000 A Pag. 78	
		516 ST6NMA Pag. 21	519 M 613AEA Pag. 31	812 N Pag. 64	2000 G Pag. 79	
		516 ST6NMM Pag. 21	519 M 6138EA Pag. 31	814 A Pag. 83	2550 A Pag. 78	
		516 ST6NPA Pag. 20	519 M 613CEA Pag. 31	824 A Pag. 64	2550 B Pag. 78	
			519 M 990A5MD Pag. 31	831 A Pag. 83	2847/3 Pag. 76	
				870 C Pag. 81	2847 A Pag. 77	

# SCOPRI LE NOVITÀ 2024



**Gamma X-Grip  
Pagina 4**



**Arredamento da officina  
Pagina 10**



**Banchi da lavoro  
Pagina 14**



**Carrelli portautensili  
Pagina 18**



**Assortimenti  
Pagina 28**



**Valigie manutenzione  
Pagina 32**



**Contenitori trasportabili  
Pagina 34**



**Giraviti  
Pagina 38**



**Inserti e chiavi maschio  
Pagina 41**



**Pinze  
Pagina 46**



**Chiavi di manovra  
Pagina 51**



**Cricchetti e bussole  
Pagina 56**



**Estrattori  
Pagina 61**



**Serraggio controllato  
Pagina 62**



**Forbici per elettricisti  
Pagina 65**



**Elettrotecnica  
Pagina 66**



**Idraulica  
Pagina 68**



**Rivettatrici  
Pagina 69**



**Manutenzione  
Pagina 70**



**Illuminazione  
Pagina 74**



**Autoriparazione  
Pagina 76**



**Pneumatica e accessori  
Pagina 84**

**Cerca gli  
ICONIC PRODUCT:  
i prodotti che fanno la differenza!**

**ICONIC PRODUCT**

## GAMMA UTENSILI X-GRIP

PERFETTA SU ESAGONI NUOVI, EFFICACE SU ESAGONI DANNEGGIATI.



**VITI E DADI CON TESTA ESAGONALE**



**VITI CON ESAGONO INCASSATO**



285 X



280 HX



235 X



280 X



235 XL



660 X

### IL PROFILO ESCLUSIVO X-GRIP

Solo USAG può darti un profilo che ti permette di svitare viti e dadi molto danneggiati.

### ANCHE PER ESAGONI PERFETTI

Se lavori su una vite o un dado intatti, il profilo X-Grip permette di trasmettere una coppia superiore rispetto ad un normale profilo e senza alcun danneggiamento.

# CHIAVI COMBinate 285 X

## FORCHETTA INCLINATA

Angolo di 15° rispetto all'asse della chiave.



YouTube

## SEZIONE A DOPPIA T

Massima resistenza alla flessione.

## OCCHIO DISASSATO

Per dadi e bulloni incassati in posizioni di difficile accesso.



## 30% PIÙ LUNGA DI UNA NORMALE CHIAVE 285

Questo permette di applicare una coppia del 30% superiore rispetto alla chiave standard.

## I VANTAGGI DEL PROFILO SPECIALE X-GRIP

- Presa perfetta su esagoni nuovi e danneggiati (fino all'80% utilizzando l'anello e 60% con la forchetta).
- Trasmette una coppia superiore rispetto a una bussola standard.
- Non danneggia gli esagoni nuovi.



8  
PEZZI

**285 X/B8**  
U02850950

### Serie di 8 chiavi combinate

- 285 X/8-10-11-12-13-14-17-19 mm.
- Fornita in busta in tessuto in altissima resistenza.

8÷19 mm

€ 115,00

**€ 79,00**

12  
PEZZI

**285 X/B12**  
U02850951

### Serie di 12 chiavi combinate

- 285 X/8-9-10-11-12-13-14-15-16-17-18-19 mm.
- Fornita in busta in tessuto in altissima resistenza.

8÷19 mm

€ 161,00

**€ 113,00**

## BUSSOLE 235 X

### ACCIAIO SPECIALE

altamente legato al cromo vanadio.  
Esecuzione cromata.



YouTube



### I VANTAGGI DEL PROFILO SPECIALE X-GRIP

- Presa perfetta su esagoni nuovi e danneggiati fino all'80%.
- Trasmette una coppia superiore rispetto a una bussola standard.
- Non danneggia gli esagoni nuovi.



### GUIDA MAGNETICA PORTABUSSOLE 559 A

- Disponibili nelle versioni con clip da 1/4", 3/8", 1/2".
- Base magnetica protetta da strato in gomma: non rovina la superficie.
- Clip orientabile a 360°, per identificare velocemente la bussola.



**235 1/2" X/SE12**  
U02350501

12  
PEZZI



Serie di 12 chiavi a bussola con bocca esagonale speciale

€115,00

**€ 79,00**

10-11-12-13-14-  
15-16-17-18-19-  
22-24 mm



**235 1/4" X/SE10**  
U02350500

10  
PEZZI



Serie di 10 chiavi a bussola con bocca esagonale speciale

€57,00

**€ 39,00**

5,5-6-7-8-9-10-  
11-12-13-14 mm

## ASSORTIMENTO CON INSERTI 660 X E BUSSOLE 235 X



23  
PEZZI

1/4"

1/4

Novità

Inserto portabussole



609 1/4" SKX  
U06090004

134 g | 120 mm | 30 | 60

### Assortimento con bussole esagonali speciali ed inserti per avvitatura

- Cassetta in bimatereale con rivestimento soft-touch.
- Marcatura interna delle bussole contenute.
- Clip di aggancio in metallo.

DESCRIZIONE	ART./MISURA	PZ.
Cricchetto reversibile con prolunga	237 1/4" SK	2
Chiavi a bussola con bocca esagonale speciale	235 1/4" X 6-8-10-12-13	5
Inserti ad intaglio	660 0,5x1	1
Inserti a croce Phillips®	660 PH 2	1
Inserti a croce Pozidriv®- SUPadriv®	660 PZ 2	1
Inserto portabussole	660 Q 1/4"	1
Inserti TORX® Tamper Resistant	660 STX T20-T25-T30-T40	4
Inserti con profilo esagonale speciale	660 X 2-2,5-3-4-5-6-7-8	8

€ 137,00

€ 79,00

## ASSORTIMENTO CON INSERTI 660 X



Novità

9  
PEZZI

2-2,5-3-4-5-  
6-7-8 mm

1/4 Bussola portainseriti

660 X/B9  
U06600100

110 mm | 20 mm | 105



YouTube

### Set di inserti con profilo esagonale speciale

- Profilo esclusivo per esagoni incassati: permette di fare presa su esagoni incassati intatti o completamente danneggiati fino al 92%.
- In acciaio speciale con finitura fosfatata.
- Inclusa bussola portainseriti 1/4-1/4".
- Fornito in astuccio di tessuto compatto.

DESCRIZIONE	ART./MISURA	PZ.
Inserti con profilo speciale	660 X 2-2,5-3-4-5-6-7-8	8
Bussola portainseriti	684 1/4	1

€ 55,50

€ 36,00

## INSERTI 660 X

### PROFILO ESCLUSIVO X-GRIP

Lo speciale design con cui sono realizzati gli inserti, permette di fare presa sugli esagoni incassati in qualunque condizione: intatti o completamente danneggiati.



### VITI DANNEGGIATE

Quando una vite con esagono incassato si danneggia, non è più possibile svitarla con normali chiavi maschio esagonali. Gli inserti 660 X permettono di svitare anche viti danneggiate fino al 92% del profilo esagonale.



## CHIAVI MASCHIO 280 X E 280 HX



### PROFILO ESCLUSIVO X-GRIP

Lo speciale design con cui sono realizzate le chiavi, permette di fare presa sugli esagoni incassati in qualunque condizione: intatti o completamente danneggiati.



### VITI DANNEGGIATE

Quando una vite con esagono incassato si danneggia, non è più possibile svitarla con normali chiavi maschio esagonali. Le chiavi 280 X e 280 HX permettono di svitare anche viti danneggiate fino al 92% del profilo esagonale.



Novità

6  
PEZZI



YouTube

### 280 HX/SE6

U02802460

**Serie di 6 chiavi maschio con profilo esagonale speciale e impugnatura bimateriale**

- 280 HX/2,5-3-4-5-6-8 mm.
- Impugnatura ergonomica bimateriale con rivestimento antiscivolo.
- Design studiato per una presa sicura durante la manovra.
- Acciaio speciale altamente legato.
- Finitura zinco fosfatata per un'elevata resistenza alla corrosione.

~~€ 99,00~~

**€ 69,00**



Novità

9  
PEZZI



YouTube

### 280 X/S9

U02800485

**Set di 9 chiavi maschio con profilo esagonale speciale**

- 280 X/1,5-2-2,5-3-4-5-6-8-10 mm.
- Modello che permette di operare con inclinazioni fino a 25% rispetto all'asse della vite.
- Acciaio speciale altamente legato.
- Finitura zinco fosfatata per un'elevata resistenza alla corrosione.
- Supporto in plastica.

~~€ 70,00~~

**€ 49,00**



# X-GRIP NEL TUO CARRELLO!

**Novità** XL



52  
PEZZI

**519 M 235X**  
U05191065

**Modulo in spugna bicolore assortito**

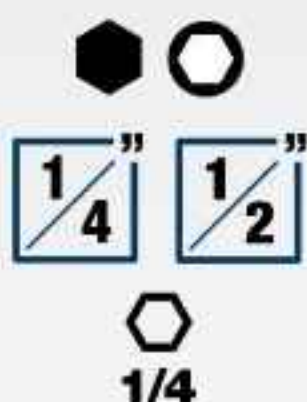

DESCRIZIONE	ART./MISURA	PZ.
Chiavi a bussola con bocca esagonale speciale	235 1/2 X10-11-12-13-14-15-16-17-18-19-22-24	12
Chiavi a bussola con bocca esagonale speciale	235 1/4 X 5,5-6-7-8-9-10-11-12-13-14	10
Chiavi a bussola lunghe con bocca esagonale speciale	235 1/2 XL 17-19-21	3
Prolunghe	236 1/2 125-250	2
Prolunghe	236 1/4 125-250	2
Cricchetto reversibile certificato IP51	237 A 1/2	1
Cricchetto reversibile certificato IP51	237 A 1/4	1
Leva a T con attacco quadro scorrevole	240 1/2 N	1
Leva a T con attacco quadro scorrevole	240 1/4	1
Snodo cardanico	241 1/2	1
Snodo cardanico	241 1/4	1
Set di 9 chiavi maschio con profilo esagonale speciale	280 X/S9 1,5-2-2,5-3-4-5-6-8-10	9
Inseriti con profilo esagonale speciale	660 X 2-2,5-3-4-5-6-7-8	8
Bussola portainseriti	684 1/4	1

~~€ 506,00~~

**€ 354,00**

**Novità** L



12  
PEZZI

**519 M 285X**  
U05191063

**Modulo in spugna bicolore assortito**

- 285 X/8-9-10-11-12-13-14-15-16-17-18-19 mm.

~~€ 171,00~~

**€ 119,00**

**Novità** L



6  
PEZZI

**519 M 280HX**  
U05191064

**Modulo in spugna bicolore assortito**

- 280 HX/2,5-3-4-5-6-8 mm.

~~€ 111,00~~

**€ 77,50**

**Vuoi creare il tuo assortimento aggiungendo altri moduli?  
Vai a pagina 31**

**Arredamento  
da officina**

**START516**

## **LINEA ARREDAMENTO START 516** **LA TUA POSTAZIONE DI LAVORO PROFESSIONALE**



 YouTube



### **LA QUALITÀ DEI NOSTRI CARRELLI 516**



Guide telescopiche da 35 mm  
con portata fino a 40Kg.  
Maniglie in ABS rinforzate.

### **PIANO DI LAVORO IN ACCIAIO O IN LEGNO AMPIO E RESISTENTE**



Profondità utile: 600 mm.  
Portata statica massima: 1000 Kg.

### **COMPATIBILE CON LA GAMMA MODULI**



Puoi assortire carrello e cassettiere  
utilizzando la gamma di moduli in  
spugna ed in plastica.



## **VUOI CREARE LA TUA POSTAZIONE SU MISURA?**

Configurala su [start516.usag.it](http://start516.usag.it)

**Include: ganci, lampade LED, presa multipla e cassetti su ruote**



DESCRIZIONE	ART	PZ
Mobili fisso con 6 cassetti	516 SA/1T	1
Mobili fisso con 7 cassetti	516 SA/1T/7	1
Carrello STAFFIT - 6 cassetti (vuoto)	516 SA/16T	1
Mobili base con portarifiuti e portarotolo	516 SA/17T	1
Cassetti su ruote per mobili base	516 SA/20T	4
Pannello forato portautensili	516 SA/51	8
Pannello forato portautensili con 3 prese SCHUKO e 2 porte USB	516 SA/6T	2
Armadio a 2 ante	516 SA/3T/2	1
Armadio a 1 ante	516 SA/3T	1
Lampada a LED	516 SA/12	2
Penali con ante basculante	516 SA/4T	5
Supporto per avvitatori	516 SA/11P	1
Riviti per mobili	516 SA/11T	6



**516 SA/CTA**  
U05160299



**Pianali in acciaio**  
1.450 mm - 516 AC/1  
2.175 mm - 516 AC/2  
**Kit angolare**  
516 SA/19T

**Arredamento per officina - pianale in acciaio**  
• Fornita con kit base di 30 ganci 516 SA/K1.

~~€ 10.669,00~~

**€ 7.469,00**



**516 SA/CTL**  
U05160300



**Pianali in legno**  
1.450 mm - 516 SAL/1  
2.175 mm - 516 SAL/2  
**Kit angolare**  
516 SA/18T

**Arredamento per officina - pianale in legno**  
• Fornita con kit base di 30 ganci 516 SA/K1.

~~€ 10.669,00~~

**€ 7.469,00**

2.100 mm 2.100 mm



**Include: ganci, lampade LED, presa multipla e cassetti su ruote**



DESCRIZIONE	ART	PZ
Mobili fisso con 7 cassetti	516 SA/1T/7	1
Mobili fisso con 6 cassetti	516 SA/1T	1
Mobili fisso con 2 ante	516 SA/2T	1
Mobili base con portarifiuti e portarotolo	516 SA/17T	1
Pannelli forati portautensili	516 SA/51	7
Pannello forato portautensili con 3 prese SCHUKO e 2 porte USB	516 SA/6T	1
Penali con ante basculante	516 SA/4T	4
Lampada a LED	516 SA/12	2
Cassetti su ruote per mobili base	516 SA/20T	4
Kit di montaggio	516 SA/14T	4
Riviti per mobili	516 SA/11T	4



**516 SA/CBA**  
U05160297



**Pianali in acciaio**  
2.175 mm  
516 AC/2 (x2)  
**Kit angolare**  
516 SA/19T

**Arredamento per officina - pianale in acciaio**  
• Fornita con kit base di 30 ganci 516 SA/K1.

~~€ 6.564,00~~

**€ 4.595,00**



**516 SA/CBL**  
U05160298



**Pianali in legno**  
2.175 mm  
516 SAL/2 (x2)  
**Kit angolare**  
516 SA/18T

**Arredamento per officina - pianale in legno**  
• Fornita con kit base di 30 ganci 516 SA/K1.

~~€ 6.564,00~~

**€ 4.595,00**



## VUOI CREARE LA TUA

Configurala su

**Include: ganci, lampade LED, presa multipla e cassetti su ruote**

DESCRIZIONE	ART	PZ
Moblie fissa con 7 cassetti	516 SA177	1
Moblie base con portariviti e portarotolo	516 SA171	1
Pannelli forati portautensili	516 SA5T	5
Pannello forato portautensili con 3 prese SCHUKO e 2 porte USB	516 SA6T	1
Panelli con ante basculante	516 SA4T	3
Armadio a 2 ante	516 SA3T2	1
Cassella START - 6 cassetti (vuoti)	516 SA16T	1
Supporto per svernatori	516 SA1TP	1
Cassetti su ruote per mobili base	516 SA20T	2
Lampade a LED	516 SA12	2
Kit di montaggio	516 SA14T	3
Ritzi per mobili	516 SA11T	3



**516 SA/PRA**  
U05160295



3.175  
2.000  
650

Pianali in acciaio  
2.175 mm - 516 AC/2

**Arredamento per officina - pianale in acciaio**

- Fornita con kit base di 30 ganci 516 SA/K1.

~~€ 5.982,00~~

**€ 4.188,00**



**516 SA/PRL**  
U05160296



3.175  
2.000  
650

Pianali in legno  
2.175 mm - 516 SAL/2

**Arredamento per officina - pianale in legno**

- Fornita con kit base di 30 ganci 516 SA/K1.

~~€ 5.982,00~~

**€ 4.188,00**

**Include: ganci, lampade LED, presa multipla e cassetti su ruote**

DESCRIZIONE	ART	PZ
Moblie fissa con 6 cassetti	516 SA171	1
Moblie fissa con 2 ante	516 SA271	1
Pannelli forati portautensili	516 SA5T	5
Pannello forato portautensili con 3 prese SCHUKO e 2 porte USB	516 SA6T	1
Panelli con ante basculante	516 SA4T	3
Armadio a 1 ante	516 SA3T1	1
Cassella START - 6 cassetti (vuoti)	516 SA16T	1
Cassetti su ruote per mobili base	516 SA20T	2
Lampade a LED	516 SA12	2
Kit di montaggio	516 SA14T	3
Ritzi per mobili	516 SA11T	3



**516 SA/STA**  
U05160293



2.675  
2.000  
650

Pianali in acciaio  
2.175 mm - 516 AC/2

**Arredamento per officina - pianale in acciaio**

- Fornita con kit base di 30 ganci 516 SA/K1.

~~€ 5.407,00~~

**€ 3.785,00**



**516 SA/STL**  
U05160294



2.675  
2.000  
650

Pianali in legno  
2.175 mm - 516 SAL/2

**Arredamento per officina - pianale in legno**

- Fornita con kit base di 30 ganci 516 SA/K1.

~~€ 5.407,00~~

**€ 3.785,00**

## POSTAZIONE SU MISURA?

start516.usag.it



**Include: ganci, lampade LED, presa multipla e cassetti su ruote**

DESCRIZIONE	ART	PZ
Moblie fisso con 6 cassetti	516 SA/1T	1
Moblie fisso con 2 ante	516 SA/2T	1
Pannelli forati portautensili	516 SA5T	3
Pannello forato portautensili con 3 prese SCHUKO e 2 porte USB	516 SA6T	1
Pensili con anta basculante	516 SA/4T	2
Armadio a 1 anta	516 SA/3T	1
Cassetti su ruote per mobili base	516 SA20T	2
Kit di montaggio	516 SA14T	2
Rialzi per mobili	516 SA11T	3



**516 SA/CA**  
U05160291



Pianali in acciaio  
1.450 mm - 516 AC/1

**Arredamento per officina - pianale in acciaio**

- Fornita con kit base di 30 ganci 516 SA/K1.

~~€ 4.140,00~~

**€ 2.898,00**



**516 SA/CL**  
U05160292



Pianali in legno  
1.450 mm - 516 SAL/1

**Arredamento per officina - pianale in legno**

- Fornita con kit base di 30 ganci 516 SA/K1.

~~€ 4.140,00~~

**€ 2.898,00**



DESCRIZIONE	ART	PZ
Moblie fisso con 6 cassetti	516 SA/1T	1
Moblie fisso con 2 ante	516 SA/2T	1
Carrello START - 6 cassetti (vuoto)	516 SA/16T	1
Rialzi per mobili	516 SA11T	2



**516 SA/BCA**  
U05160289

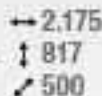

Pianali in acciaio  
2.175 mm - 516 AC/2

**Banco da lavoro - pianale in acciaio**

~~€ 2.468,00~~

**€ 1.728,00**



**516 SA/BCL**  
U05160290



Pianali in legno  
2.175 mm - 516 SAL/2

**Banco da lavoro - pianale in legno**

~~€ 2.468,00~~

**€ 1.728,00**



## **SISTEMA BANCHI 506**

### **RESISTENZA E STABILITÀ AL TOP**



YouTube



#### **ACCESSORI LATERALI**

compatibile con la linea 516 AC  
(solo modelli 506 KA e KL).



#### **CASSETTI MAGGIORATI**

montati su guide ad alte prestazioni.



#### **MONTANTI IN LAMIERA**

d'acciaio spessore 1,2 mm per la  
massima resistenza.



Tutti i modelli sono disponibili con  
piano di lavoro in acciaio spessore  
3 mm o legno multistrato da 30 mm.



Tutti i modelli sono predisposti  
con forature per essere fissati al  
pavimento o affiancati tra loro.

2.000 kg

**ACCIAIO**

**2 CASSETTI**

**506 KA**  
U05060256

**RAL 9005**

### Postazione di lavoro con piano in acciaio

- Piano di lavoro in lamiera d'acciaio zincata spessore 3 mm con bordi anticaduta da 37 mm.
- Struttura resistente a 6 montanti.
- Doppio cassetto ad estrazione totale con serratura.
- Ante in lamiera d'acciaio con cerniere regolabili.
- Ripiano interno in dotazione.
- Pannelli laterali con agganci per accessori linea 516.
- Predisposizione per il fissaggio a pavimento.
- Portata statica: 2000 Kg.
- Dimensioni interne cassette: 830x550x110 mm.
- Dimensioni interne vano con ante: 860x350x440 mm
- Verniciato colore nero RAL 9005
- Consegnato smontato.

~~€ 1.555,00~~

**€ 1.089,00**



150 kg | mm | 2.000 | 910 | 700



2000 mm

2.000 kg

**LEGNO**

**2 CASSETTI**

**506 KL**  
U05060246

**RAL 9005**

### Postazione di lavoro con piano in legno

- Piano di lavoro in legno multistrato spessore 30 mm.
- Struttura resistente a 6 montanti.
- Doppio cassetto ad estrazione totale con serratura.
- Ante in lamiera d'acciaio con cerniere regolabili.
- Ripiano interno in dotazione.
- Pannelli laterali con agganci per accessori linea 516.
- Predisposizione per il fissaggio a pavimento.
- Portata statica: 2000 Kg.
- Dimensioni interne cassette: 830x550x110 mm.
- Dimensioni interne vano con ante: 860x350x440 mm
- Verniciato colore nero RAL 9005
- Consegnato smontato.

~~€ 1.713,00~~

**€ 1.199,00**



140 kg | mm | 2.000 | 910 | 700



2000 mm

# Banchi da lavoro



## 506 TAC

RAL 9006

ACCIAIO

### Banchi da lavoro con piano in acciaio

- Piano di lavoro in lamiera d'acciaio zincata spessore 3 mm con bordi anticaduta da 37 mm.
- Montanti e ripiano inferiore in lamiera d'acciaio spessore 1,2 mm.
- Fori laterali per il fissaggio di più banchi affiancati.
- Predisposizione per il fissaggio a pavimento.
- 6 montanti per il modello di lunghezza 2 metri.
- Spazio tra due montanti: 864 mm.
- Spazio tra il ripiano di appoggio ed il piano di lavoro: 525 mm.
- Dimensioni interne cassetti:
  - L 1000 e L 2000: 830x550x110 mm
  - L 1500: 1280x550x110 mm
- Consegnato smontato.

CODICE	DIMENSIONI LxPxH	PESO	N° cassetti	<del>€</del>	€
U05060154	1046x700x910 mm	85 kg	1	€548,00	€ 378,00
U05060155	1500x700x910 mm	85 kg	1	€669,00	€ 468,00
U05060156	2000x700x910 mm	110 kg	2	€910,00	€ 637,00



## 506 TLC

RAL 9006

LEGNO

### Banchi da lavoro con piano in legno

- Piano di lavoro in legno multistrato spessore 30 mm.
- Montanti e ripiano inferiore in lamiera d'acciaio spessore 1,2 mm.
- Fori laterali per il fissaggio di più banchi affiancati.
- Predisposizione per il fissaggio a pavimento.
- 6 montanti per il modello di lunghezza 2 metri.
- Spazio tra due montanti: 864 mm.
- Spazio tra il ripiano di appoggio ed il piano di lavoro: 525 mm.
- Dimensioni interne cassetti:
  - L 1000 e L 2000: 830x550x110 mm
  - L 1500: 1280x550x110 mm
- Consegnato smontato.

CODICE	DIMENSIONI LxPxH	PESO	N° cassetti	<del>€</del>	€
U05060144	1046x700x910 mm	55 kg	1	€640,00	€ 448,00
U05060145	1500x700x910 mm	75 kg	1	€798,00	€ 559,00
U05060146	2000x700x910 mm	100 kg	2	€1.068,00	€ 748,00

## 501 P

RAL 9005

### Pannelli forati

- Diametro fori 5 mm.
- Lamiera di acciaio, spessore 1,2 mm.

CODICE	MIS	DIMENSIONI INT. LxPxH	PESO	<del>€</del>	€
U050101030	C	1000x800x40mm	9,5 kg	€110,00	€ 77,00
U050101040	A	1500x800x40 mm	13,5 kg	€185,00	€ 129,00
U050101050	B	2000x800x40 mm	17,5 kg	€211,00	€ 148,00

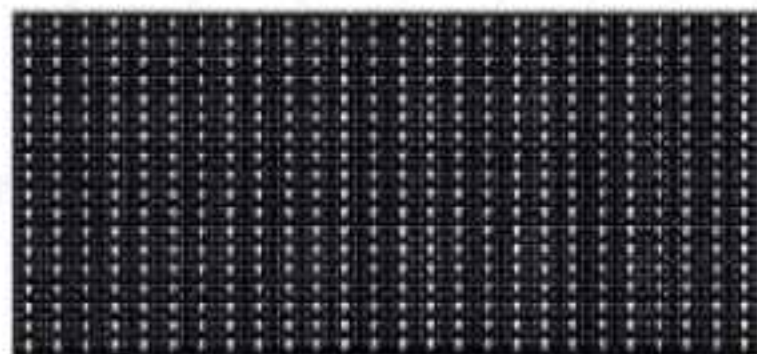





## 506 TA

RAL 9005

ACCIAIO

### Banchi da lavoro con piano in acciaio

- Piano di lavoro in lamiera d'acciaio zincata spessore 3 mm con bordi anticaduta da 37 mm.
- Montanti e ripiano inferiore in lamiera d'acciaio spessore 1,2 mm.
- Fori laterali per il fissaggio di più banchi affiancati.
- Predisposizione per il fissaggio a pavimento.
- 6 montanti per il modello di lunghezza 2 metri.
- Spazio tra due montanti: 864 mm.
- Spazio tra il ripiano di appoggio ed il piano di lavoro: 660 mm.
- Consegnato smontato.

CODICE	DIMENSIONI LxPxH	PESO	<del>€</del>	€
U05060054	1046x700x910 mm	50 kg	<del>356,00</del>	€ 249,00
U05060055	1500x700x910 mm	60 kg	<del>427,00</del>	€ 299,00
U05060056	2000x700x910 mm	80 kg	<del>542,00</del>	€ 379,00



## 506 TL

RAL 9005

LEGNO

### Banchi da lavoro con piano in legno

- Piano di lavoro in legno multistrato spessore 30 mm.
- Montanti e ripiano inferiore in lamiera d'acciaio spessore 1,2 mm.
- Fori laterali per il fissaggio di più banchi affiancati.
- Predisposizione per il fissaggio a pavimento.
- 6 montanti per il modello di lunghezza 2 metri.
- Spazio tra due montanti: 864 mm.
- Spazio tra il ripiano di appoggio ed il piano di lavoro: 660 mm.
- Consegnato smontato.

CODICE	DIMENSIONI LxPxH	PESO	<del>€</del>	€
U05060044	1046x700x910 mm	40 kg	<del>456,00</del>	€ 319,00
U05060045	1500x700x910 mm	50 kg	<del>556,00</del>	€ 389,00
U05060046	2000x700x910 mm	70 kg	<del>700,00</del>	€ 490,00

## 506 TC

RAL 9005

### Cassetti per banchi da lavoro

- Compatibili con banchi 506 TA e 506 TL.
- Guide telescopiche con resistenza al carico fino a 60 Kg.

CODICE	MIS	DIMENSIONI INT. LxPxH	PESO	<del>€</del>	€
U05060154Q	1	830x550x110 mm	15 kg	<del>104,00</del>	€ 129,00
U05060155Q	2	1280x550x110 mm	25 kg	<del>242,00</del>	€ 169,00



### CARRELLO 516 START RESISTENTE ED AFFIDABILE.



YouTube



Piano di lavoro da 460 x 560 mm  
con bordi anticaduta da 15 mm



Guide resistenti da 35 mm  
con portata fino a 40 kg



Maniglie in ABS rinforzate  
con apertura basculante



#### Risparmia il tuo tempo

Tutti i carrelli a cassettera USAG sono subito pronti all'uso, perchè forniti con le ruote già montate alla struttura.



800 kg

5  
CASSETTI

3  
MODELLI

54 kg | mm | 779  
972  
515

**516 ST5V**  
U05160105

RAL  
3020

#### Carrello START (vuoto)

- Dimensioni interne:
  - 2 cassetti 570x420x60 mm.
  - 2 cassetti 570x420x130 mm.
  - 1 cassetto 570x420x270 mm.

~~€ 649,00~~

**€ 459,00**



800 kg

6  
CASSETTI

3  
MODELLI

55 kg | mm | 779  
972  
515

**516 ST6V**  
U05160106

RAL  
3020

#### Carrello START (vuoto)

**516 ST6NV**  
U05160116

RAL  
9005

#### Carrello START (vuoto)

- Dimensioni interne:
  - 3 cassetti 570x420x60 mm.
  - 2 cassetti 570x420x130 mm.
  - 1 cassetto 570x420x200 mm.

~~€ 715,00~~

**€ 509,00**



800 kg

7  
CASSETTI

3  
MODELLI

56 kg | mm | 779  
972  
515

**516 ST7V**  
U05160107

RAL  
3020

#### Carrello START (vuoto)

**516 ST7NV**  
U05160117

RAL  
9005

#### Carrello START (vuoto)

- Dimensioni interne:
  - 5 cassetti 570x420x60 mm.
  - 1 cassetto 570x420x130 mm.
  - 1 cassetto 570x420x200 mm.

~~€ 781,00~~

**€ 549,00**



**516 ST8V**  
U05160108

RAL 3020

**Carrello START (vuoto)**

- Dimensioni interne:
  - 6 cassetti 570x420x60 mm.
  - 2 cassetti 570x420x130 mm.

~~€ 847,00~~

**€ 599,00**



**516 STXL6V**  
U05160146

RAL 3020

**Carrello START (vuoto)**

- Dimensioni interne:
  - 3 cassetti 760x420x60 mm.
  - 2 cassetti 760x420x130 mm.
  - 1 cassetto 760x420x200 mm.

~~€ 865,00~~

**€ 599,00**



**516 STXL6NV**  
U05160156

RAL 9005

**Carrello START (vuoto)**

- Dimensioni interne:
  - 3 cassetti 760x420x60 mm.
  - 2 cassetti 760x420x130 mm.
  - 1 cassetto 760x420x200 mm.

~~€ 865,00~~

**€ 599,00**



## Antiribaltamento



**516 STS7V**  
U05160127

RAL 3020

**Carrello START (vuoto)**

- Dimensioni interne:
  - 5 cassetti 570x420x60 mm.
  - 1 cassetto 570x420x130 mm.
  - 1 cassetto 570x420x200 mm.

~~€ 915,00~~

**€ 639,00**



**516 STS7NV**  
U05160137

RAL 9005

**Carrello START (vuoto)**

- Dimensioni interne:
  - 5 cassetti 570x420x60 mm.
  - 1 cassetto 570x420x130 mm.
  - 1 cassetto 570x420x200 mm.

~~€ 915,00~~

**€ 639,00**



**516 STC4V**  
U05160104

RAL 3020

**Cassettiera START (vuota)**

- Dimensioni interne:
  - 3 cassetti: 570x420x60 mm.
  - 1 cassetto: 570x420x130 mm.

~~€ 500,00~~

**€ 349,00**

**NON TROVI IL TUO**  
Configuralo su



**6**  
CASSETTI

**3**  
MODULI

**RISPARMI**  
**€ 150**

Rispetto all'acquisto di carrello ed assortimento separati.

**157**  
PEZZI



**516 ST6PM**  
U05160630

RAL  
3020

**516 ST6NPM**  
U05161630

RAL  
9006

**Carrello START con assortimento MANUTENZIONE - 4 cassette**

~~€ 1.949,00~~

**€ 988,00**



**6**  
CASSETTI

**3**  
MODULI

**RISPARMI**  
**€ 150**

Rispetto all'acquisto di carrello ed assortimento separati.

**142**  
PEZZI



**516 ST6PA**  
U05160629

RAL  
3020

**516 ST6NPA**  
U05161629

RAL  
9006

**Carrello START con assortimento AUTORIPARAZIONE - 2 cassette**

~~€ 1.863,00~~

**€ 988,00**

## ASSORTIMENTO MANUTENZIONE



519/613AEA 519/613CEA 519 SK692V 519/285A1 519/150AX 519 SK692V



519/324H 519/324TX 519 SK692V + 692 J32 519 SK692V 519/900A1 519/382F

## ASSORTIMENTO AUTORIPARAZIONE



519/613AEA 519/613CEA 519 SK692V + 692 J32 519/324H 519/285A1 519/150AX



**CHIAVI A T SNODATE**  
7-8-10-12-13-17 mm

DESCRIZIONE	ART	PZ
Bussole esagonali, cricchetto (237 A), accessori 1/4 ed inserti	519/613AEA	42
Bussole esagonali, cricchetto (237 A) ed accessori 1/2	519/613CEA	22
Chiavi combinate (6-24 mm) + chiavi maschio esagonali (1,5-10 mm)	519/285A1	25
Pirza universale, pirza regolabile, tronchese, pirza becchi lunghi e pirza grip	519/150AX	5
Giranti per viti ad intaglio ed a croce PHILLIPS	519/324H	10
Giranti per viti TORX	519/324TX	9
Lime a taglio mezzodolce	519/900A1	4
Martello per meccanici, mazzuola, cacciapire, scalpello e bulino	519/382F	8
Assortimento di inserti con cricchetto reversibile	692 J32	32

DESCRIZIONE	ART	PZ
Bussole esagonali, cricchetto (237 A), accessori 1/4 ed inserti	519/613AEA	42
Bussole esagonali, cricchetto (237 A) ed accessori 1/2	519/613CEA	22
Chiavi combinate (6-24 mm) + chiavi maschio esagonali (1,5-10 mm)	519/285A1	25
Pirza universale, pirza regolabile, tronchese, pirza becchi lunghi e pirza grip	519/150AX	5
Chiavi a T snodate con bocca esagonale (7-8-10-12-13-17 mm)	276 CE	6
Assortimento di inserti con cricchetto reversibile	692 J32	32

## ASSORTIMENTO IDEALE?

kitplanner.usag.it



6 CASSETTI  
3 MODULI

RISPARMI  
€ 220

Rispetto all'acquisto di carrello ed assortimento separati.



6 CASSETTI  
3 MODULI

RISPARMI  
€ 220

Rispetto all'acquisto di carrello ed assortimento separati.

156 PEZZI

516 ST6MM  
U05160628

RAL 3020



516 ST6NMM  
U05161628

RAL 9006

Carrello START con assortimento MANUTENZIONE - 4 cassette

€ 2.187,00

€ 1.098,00

155 PEZZI

516 ST6MA  
U05160627

RAL 3020



516 ST6NMA  
U05161627

RAL 9006

Carrello START con assortimento AUTORIPARAZIONE - 3 cassette

€ 2.171,00

€ 1.098,00

### ASSORTIMENTO MANUTENZIONE



519 M 613AEA 519 M 613CEA 519 M 285A1



519 M 127C 519 M 150AX 519 MSK6



519 M 324H 519 M 324STX 519 MSK6+ 692 J32



519 M 990ASB 519 M 382F 519 MSK6

### ASSORTIMENTO AUTORIPARAZIONE



519 M 285A1 519 M 324H 519 M 324STX



519 M 613AEA 519 M 612CLA



519 M 276C



CHIAVI A T SNODATE  
8-10-13-17 mm

DESCRIZIONE	ART	PZ
Bussole esagonali, cricchetto (237 A), accessori 1/4 ed inserti	519 M 613AEA	46
Bussole esagonali, cricchetto (237 A) ed accessori 1/2	519 M 613CEA	23
Chiavi combinate (6-7-8-9-10-12-13-14-15-16-17-18-19-22-24 mm)	519 M 285A1	17
Pinze per anelli elastici interni ed esterni 15-25 e 19-60	519 M 127C	6
Pinza universale, pinza regolabile, tronchese, pinza becchi lunghi e pinza grip	519 M 150AX	5
Graffi per viti ad intaglio ed a croce PHILLIPS	519 M 324H	7
Graffi per viti TORX	519 M 324STX	8
Lime a taglio mezzodisco	519 M 990ASB	5
Martello per meccanici, mazzuola, cacciapipino, scalpello a bulino	519 M 382F	7
Assortimento di inserti con cricchetto reversibili	692 J32	32

DESCRIZIONE	ART	PZ
Bussole esagonali, cricchetto (237 A), accessori 1/4 ed inserti	519 M 613AEA	46
Bussole esagonali lunghe e corte, cricchetto (237 A) ed accessori 1/2	519 M 612CLA	35
Chiavi combinate (6-7-8-9-10-12-13-14-15-16-17-18-19-22-24 mm)	519 M 285A1	17
Graffi per viti ad intaglio ed a croce PHILLIPS	519 M 324H	7
Graffi per viti TORX	519 M 324STX	8
Pinze per anelli elastici, pinza universale, pinza becchi lunghi, chiavi snodate con bussola esagonale (8-10-13-17 mm), assortimento di inserti con cricchetto	519 M 276C	42

Vuoi solo l'assortimento? Vai a pagina 28



## NON TROVI IL TUO ASSORTIMENTO IDEALE?

Configuralo su [kitplanner.usag.it](http://kitplanner.usag.it)



6 CASSETTI

4 MODELLI

RISPARMI  
€ 260

Rispetto all'acquisto di carrello ed assortimento separati.

301 PEZZI

516 STXL6MM  
U05160632

RAL 3020

Carrello START con assortimento MANUTENZIONE - 4 cassette

€ 3.449,00

€ 1.758,00



6 CASSETTI

4 MODELLI

RISPARMI  
€ 260

Rispetto all'acquisto di carrello ed assortimento separati.

301 PEZZI

516 STXL6NMM  
U05161632

RAL 9005

Carrello START con assortimento MANUTENZIONE - 4 cassette

€ 3.449,00

€ 1.758,00

## ASSORTIMENTO MANUTENZIONE



519 M 612CLA

519 M 613BEA

519 M 613AEA



519 M 285KA

519 M 285A1

519 M 285A2

519 M 294B



519 M 324H

519 M 324STX

519 M 280HG

519 M 280N1



519 M 127C

519 M 150AX

519 M 382F

519 M 990ASB

### DESCRIZIONE

### ART

### PZ

Bussole esagonali, cricchetto (237 A), accessori 1/4 ed inserti	519 M 613AEA	46
Bussole esagonali, cricchetto (237 A) ed accessori 3/8	519 M 613BEA	20
Bussola esagonali lunghe e corte, cricchetto (237 A) ed accessori 1/2	519 M 612CLA	35
Chiavi combinate a cricchetto reversibili (8-9-10-1-12-13-14-15-16-17-18-19 mm)	519 M 285 KA	12
Chiavi combinate (8-7-8-9-10-1-12-13-14-15-16-17-18-19-22-24 mm)	519 M 285A1	17
Chiavi combinate (27-29-30-32-34 mm)	519 M 285A2	6
Chiave a rullino rapida e corta, pinza autobloccante e forbice	519 M 294B	4
Graviti per viti ad intaglio ed a croce PHILLIPS	519 M 324H	7

### DESCRIZIONE

### ART

### PZ

Graviti per viti TORX	519 M 324STX	8
Chiavi maschio esagonali con impugnatura (3-4-5-6-7-8-10 mm)	519 M 280HG	7
Cassetta inserti assortita e chiavi maschio esagonali / TORX	519 M 280N1	117
Pinze per anelli elastici interni ed esterni 15-25 e 19-60	519 M 127C	6
Pinza universale, pinza regolabile, tronchese, pinza becchi lunghi e pinza grip	519 M 150AX	5
Lime a taglio mezzodolce	519 M 990ASB	5
Martello per meccanici, mazzuola, cacciavite, scalpello e bulino	519 M 382F	7

Vuoi solo l'assortimento? Vai a pagina 28



3  
RIPIANI

25 kg | mm | 901  
849  
452

**504 SR**  
U05040004

RAL  
3020

### Carrello multiuso

- 3 ripiani da 770x448 mm.
- Ripiani coperti da tappetini in ABS da 2 mm.
- Bordi anticaduta da 37 mm su tutti e 3 i ripiani.
- Maniglia in tubolare d'acciaio diametro 25 mm.
- Fianchi predisposti per gli accessori laterali 516.
- Due ruote pivotanti e due ruote fisse (Ø 100 mm) di cui una con freno.
- Fornito smontato.
- Portata massima: 200 Kg.



**504 SN**  
U05040014

RAL  
9005

### Carrello multiuso

~~€ 215,00~~

**€ 149,00**



Compatibile con gli accessori della linea 516



Maniglia in tubolare d'acciaio Ø 25 mm.



Ripiani da 770x448 mm con bordo anticaduta da 37 mm.



Ruote antiolio Ø 100 mm.



32 kg | mm | 901  
849  
452

3  
RIPIANI

1  
CASSETTO

3  
MODULI



**COMPATIBILE CON LA GAMMA MODULI**



**504 SNA**  
U05040015

RAL  
9005

### Carrello multiuso con cassetto

- 3 ripiani da 770x448 mm.
- Ripiani coperti da tappetini in ABS da 2 mm.
- Bordi anticaduta da 37 mm su tutti e 3 i ripiani.
- Maniglia in tubolare d'acciaio diametro 25 mm.
- Fianchi predisposti per gli accessori laterali 516.
- Due ruote pivotanti e due ruote fisse (Ø 100 mm) di cui una con freno.
- Cassetto con guide telescopiche da 20 Kg.
- Doppie chiavi in dotazione.
- Dimensioni interne cassetto: 570x420x60 mm.
- Fornito smontato.
- Portata massima: 200 Kg.

~~€ 328,00~~

**€ 229,00**



## CARRELLO 519 RACING LA TUA POSTAZIONE DI LAVORO AL TOP.



**DUE RUOTE  
CON FRENO**

Piano di lavoro ampio  
con doppia maniglia

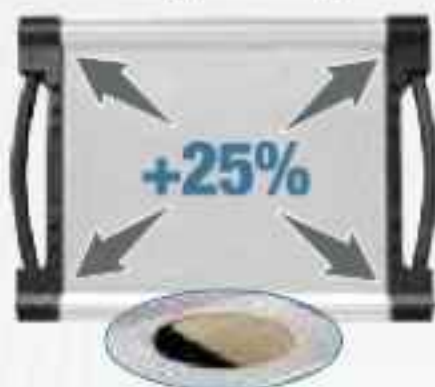

Doppio strato  
Sopra: lastra in alluminio da 2 mm.  
Sotto: piano in legno da 15 mm.



Paraurti in gomma su  
telaio e cassetti.



Maniglie ergonomiche  
basculanti in alluminio



### Risparmia il tuo tempo

Tutti i carrelli a cassetteria USAG sono subito pronti all'uso, perchè forniti con le ruote già montate alla struttura.



900 kg

**8**  
CASSETTI  
**3**  
MODULI

79 kg | mm | 814  
1005  
575

**519 RS8/3V**  
U05190508

**RAL 3020**

**Carrello RACING (vuoto)**

- Dimensioni interne:
  - 6 cassetti 570x420x60 mm.
  - 2 cassetti 570x420x130 mm.

~~€ 1.366,00~~

**€ 956,00**



900 kg

**7**  
CASSETTI  
**3**  
MODULI

77 kg | mm | 814  
1005  
575

**519 RS7/3V**  
U05190507

**RAL 3020**

**Carrello RACING (vuoto)**

- Dimensioni interne:
  - 5 cassetti 570x420x60 mm.
  - 1 cassetto 570x420x130 mm.
  - 1 cassetto 570x420x200 mm.

~~€ 1.257,00~~

**€ 880,00**



900 kg

**6**  
CASSETTI

**3**  
MODULI

75 kg | mm | 814  
1005  
575

**519 RS6/3V**  
U05190506

**RAL 3020**

**Carrello RACING (vuoto)**

**519 RS6/3NV**  
U05190516

**RAL 9005**

**Carrello RACING (vuoto)**

- Dimensioni interne:
  - 4 cassetti 570x420x60 mm.
  - 1 cassetto 570x420x130 mm.
  - 1 cassetto 570x420x270 mm.

~~€ 1.145,00~~

**€ 802,00**





**519 RS6/4V**  
U05190546

Carrello RACING (vuoto)

**519 RS6/4NV**  
U05190566

Carrello RACING (vuoto)

- Dimensioni interne:
  - 4 cassetti 760x420x60 mm.
  - 1 cassetto 760x420x130 mm.
  - 1 cassetto 760x420x270 mm.

~~€ 1.334,00~~ **€ 934,00**



**519 RS7/5V**  
U05190556

Carrello RACING (vuoto)

- Dimensioni interne:
  - 5 cassetti 950x420x60 mm.
  - 1 cassetto 950x420x130 mm.
  - 1 cassetto 950x420x200 mm.

~~€ 1.747,00~~ **€ 1.223,00**



**519 RB07/3V**  
U05190097

Carrello RACING con anta laterale (vuoto)

- Dimensioni interne:
  - 5 cassetti 570x420x60 mm.
  - 1 cassetto 570x420x130 mm.
  - 1 cassetto 570x420x200 mm.
- Vano laterale: 380x400x720 mm.

~~€ 1.747,00~~ **€ 1.223,00**



**519 RBU6/3V**  
U05190098

Banco da lavoro mobile RACING (vuoto)

- Dimensioni interne:
  - 3 cassetti 570x420x60 mm.
  - 2 cassetti 570x420x130 mm.
  - 1 cassetto 570x420x200 mm.
- Vano laterale: 380x524x704 mm.

~~€ 2.186,00~~ **€ 1.530,00**



**519 RSC4/3V**  
U05190534

Cassettiera RACING (vuota)

- Dimensioni interne:
  - 3 cassetti: 570x420x60 mm.
  - 1 cassetto: 570x420x130 mm.

~~€ 835,00~~ **€ 584,00**



**519 RSC4/4V**  
U05190544

Cassettiera RACING (vuota)

- Dimensioni interne:
  - 3 cassetti: 760x420x60 mm.
  - 1 cassetto: 760x420x130 mm.

~~€ 964,00~~ **€ 674,00**



**519 RSC4/5V**  
U05190554

Cassettiera RACING (vuota)

- Dimensioni interne:
  - 3 cassetti: 950x420x60 mm.
  - 1 cassetto: 950x420x130 mm.

~~€ 1.085,00~~ **€ 759,00**

**NON TROVI IL TUO**  
Configuralo su



**6** CASSETTI  
**3** MODULI

**RISPARMI**  
**€ 300**

Rispetto all'acquisto di carrello ed assortimento separati.



**6** CASSETTI  
**3** MODULI

**RISPARMI**  
**€ 300**

Rispetto all'acquisto di carrello ed assortimento separati.

**156**  
PEZZI

**519 RS6/3MM**  
U05190628

**RAL 3020**



**519 RS6/3NMM**  
U05191628

**RAL 9005**

**Carrello RACING con assortimento MANUTENZIONE - 4 cassette**

€ 2.617,00

**€ 1.310,00**

**155**  
PEZZI

**519 RS6/3MA**  
U05190627

**RAL 3020**



**519 RS6/3NMA**  
U05191627

**RAL 9005**

**Carrello RACING con assortimento AUTORIPARAZIONE - 3 cassette**

€ 2.601,00

**€ 1.310,00**

## ASSORTIMENTO MANUTENZIONE



519 M 613AEA 519 M 613CEA 519 M 285A1



519 M 127C 519 M 150AX 519 MSK6



519 M 324H 519 M 324STX 519 MSK6+ 602 J32



519 M 990A5B 519 M 382 519 MSK6

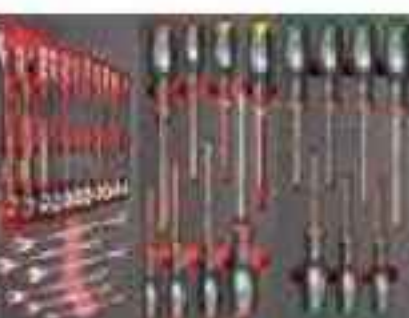

519 M 285A1 519 M 324H 519 M 324STX

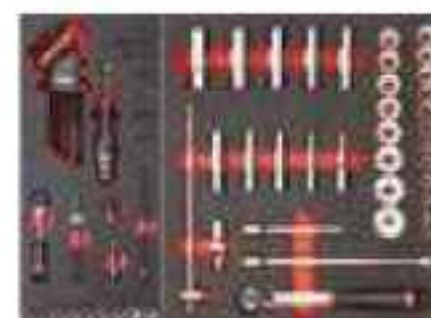

519 M 613AEA 519 M 612CLA

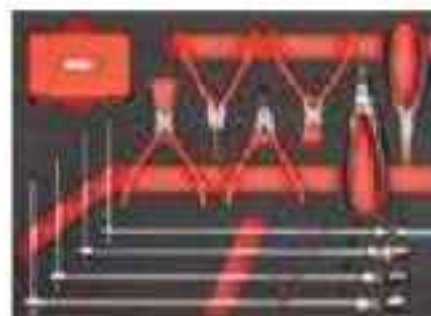

519 M 276C



**CHIAVI A T SNODATE**  
8-10-13-17 mm

### DESCRIZIONE

DESCRIZIONE	ART	PZ
Bussole esagonali, cricchetto (237 A), accessori 1/4 ed inserti	519 M 613AEA	40
Bussole esagonali, cricchetto (237 A) ed accessori 1/2	519 M 613CEA	23
Chiavi combinate (6-7-8-9-10-11-12-13-14-15-16-17-18-19-22-24 mm)	519 M 285A1	17
Pinze per anelli elastici interni ed esterni 15-25 o 19-60	519 M 127C	6
Pinza universale, pinza regolabile, tronchese, pinza becchi lunghi o pinza grip	519 M 150AX	5
Graviti per viti ad intaglio ed a croce PHILLIPS	519 M 324H	7
Graviti per viti TORX	519 M 324STX	8
Lime a taglio mezzodolce	519 M 990A5B	5
Martello per meccanici, mazzuola, cacciapigna, scalpello e bulino	519 M 382F	7
Assortimento di inserti con cricchetto reversibile	602 J32	32

### DESCRIZIONE

DESCRIZIONE	ART	PZ
Bussole esagonali, cricchetto (237 A), accessori 1/4 ed inserti	519 M 613AEA	46
Bussole esagonali lunghe e corte, cricchetto (237 A) ed accessori 1/2	519 M 612CLA	35
Chiavi combinate (6-7-8-9-10-11-12-13-14-15-16-17-18-19-22-24 mm)	519 M 285A1	17
Graviti per viti ad intaglio ed a croce PHILLIPS	519 M 324H	7
Graviti per viti TORX	519 M 324STX	8
Pinze per anelli elastici, pinza universale, pinza becchi lunghi, chiavi snodate con bussola esagonale (8-10-13-17 mm), assortimento di inserti con cricchetto	519 M 276C	42

## ASSORTIMENTO IDEALE?

kitplanner.usag.it



6 CASSETTI  
4 MODULI

RISPARMI  
€ 400

Rispetto all'acquisto di carrello ed assortimento separati.



6 CASSETTI  
4 MODULI

RISPARMI  
€ 400

Rispetto all'acquisto di carrello ed assortimento separati.

301 PEZZI

519 RS6/4MM

U05190632

RAL 3020

Carrello RACING con assortimento MANUTENZIONE - 4 cassette

€ 3.918,00

€ 1.953,00

301 PEZZI

519 RS6/4NMM

U05191632

RAL 9005

Carrello RACING con assortimento MANUTENZIONE - 4 cassette

€ 3.918,00

€ 1.953,00

## ASSORTIMENTO MANUTENZIONE



519 M 612CLA

519 M 613BEA

519 M 613AEA



519 M 285KA

519 M 285A1

519 M 285A2

519 M 294B



519 M 324H

519 M 324STX

519 M 280HG

519 M 280N1



519 M 127C

519 M 150AX

519 M 382F

519 M 990A5B

### DESCRIZIONE

DESCRIZIONE	ART	PZ
Bussole esagonali, cricchetto (237 A), accessori 1/4 ed inserti	519 M 613AEA	46
Bussole esagonali, cricchetto (237 A) ed accessori 3/8	519 M 613BEA	20
Bussole esagonali lunghe e corte, cricchetto (237 A) ed accessori 1/2	519 M 612CLA	35
Chiavi combinate a cricchetto reversibili (8-9-10-11-12-13-14-15-16-17-18-19 mm)	519 M 285KA	12
Chiavi combinate (8-7-8-9-10-11-12-13-14-15-16-17-18-19-22-24 mm)	519 M 285A1	17
Chiavi combinate (27-29-30-32-34 mm)	519 M 285A2	5
Chiave a rullino rapida e corta, pinza autobloccante e forbice	519 M 294B	4
Graviti per viti ad intaglio ed a croce PHILLIPS	519 M 324H	7

### DESCRIZIONE

DESCRIZIONE	ART	PZ
Graviti per viti TORX	519 M 324STX	8
Chiavi maschio esagonali con impugnatura (3-4-5-6-7-8-10 mm)	519 M 280HG	7
Cassette inserti assortite e chiavi maschio esagonali / TORX	519 M 280N1	117
Pinza per anelli elastici interni ed esterni 15-25 e 19-60	519 M 127C	6
Pinza universale, pinza regolabile, tronchese, pinza bocchi lunghi e pinza grip	519 M 150AX	5
Lime a taglio mezzodice	519 M 990A5B	5
Martello per meccanici, mazzuola, cacciapine, scalpello e bulino	519 M 382F	7

Vuoi solo l'assortimento? Vai a pagina 28



519 M 613AEA 519 M 613CEA 519 M 285A1



519 M 127C 519 M 150AX 519 MSK6



519 M 324H 519 M 324STX 519 MSK6+ 692 J32



519 M 990ASB 519 M 382 519 MSK0



519 M 285A1 519 M 324H 519 M 324STX

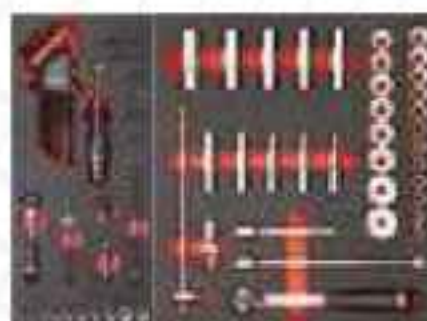

519 M 613AEA 519 M 612CLA



519 M 276C



**CHIAVI A T SNODATE**  
8-10-13-17 mm

**495 MB**  
U04950628

**156**  
PEZZI



**Assortimento MANUTENZIONE - 4 cassetti**

DESCRIZIONE	ART	PZ
Bussole esagonali, cricchetto (237 A), accessori 1/4 ed inserti	519 M 613AEA	46
Bussole esagonali, cricchetto (237 A) ed accessori 1/2	519 M 613CEA	23
Chiavi combinate (6-7-8-9-10-11-12-13-14-15-16-17-18-19-22-24 mm)	519 M 285A1	17
Pinze per anelli elastici interni ed esterni 15-25 e 19-60	519 M 127C	6
Pinza universale, pinza regolabile, tronchese, pinza bocchi lunghi e pinza grip	519 M 150AX	5
Giretti per viti ad intaglio ed a croce PHILLIPS	519 M 324H	7
Giretti per viti TORX	519 M 324STX	8
Lime a taglio mezzodisco	519 M 990ASB	5
Martello per meccanici, mazzuola, cacciapino, scalpello e bulino	519 M 382F	7
Assortimento di inserti con cricchetto reversibile	692 J32	32

~~€ 1.472,00~~

**€ 809,00**

**495 MAA**  
U04950627

**155**  
PEZZI



**Assortimento AUTORIPARAZIONE - 3 cassetti**

DESCRIZIONE	ART	PZ
Bussole esagonali, cricchetto (237 A), accessori 1/4 ed inserti	519 M 613AA-A	46
Bussole esagonali lunghe e corte, cricchetto (237 A) ed accessori 1/2	519 M 613CA A	36
Chiavi combinate (6-7-8-9-10-11-12-13-14-15-16-17-18-19-22-24 mm)	519 M 285A1	17
Giretti per viti ad intaglio ed a croce PHILLIPS	519 M 324H	7
Giretti per viti TORX	519 M 324STX	8
Pinze per anelli elastici, pinza universale, pinza bocchi lunghi, chiavi snodate con bussola esagonale (8-10-13-17 mm), assortimento di inserti con cricchetto	519 M 276C	42

~~€ 1.456,00~~

**€ 809,00**



519 M 612CLA 519 M 613BEA 519 M 613AEA



519 M 206KA 519 M 285A1 519 M 285A2 519 M 294B

**301**  
PEZZI



**495 MC**  
U04950632

**Assortimento MANUTENZIONE**  
**4 cassetti**

~~€ 2.584,00~~

**€ 1.419,00**



519 M 324H 519 M 324STX 519 M 280HG 519 M 280N1



519 M 127C 519 M 150AX 519 M 382F 519 M 990ASMD

## MODULI IN PLASTICA



519/613AEA 519/613CEA 519 SK692V



519/285A1 519/150AX 519 SK692V



519/324H 519/324TX 519 SK692V + 692 J32



519 SK692V 519/990A1 519/382F



519/613AEA 519/613CEA 519 SK692V + 692 J32



519/324H 519/285A1 519/150AX

**CHIAVI A T SNODATE**  
7-8-10-12-13-17 mm

DESCRIZIONE	ART	PZ
Bussole esagonali, cricchetto (237 A), accessori 1/4 ed inserti	519 M 613AEA	48
Bussole esagonali, cricchetto (237 A) ed accessori 3/8	519 M 613BEA	20
Bussola esagonali lungo o corto; cricchetto (237 A) ed accessori 1/2	519 M 612CLA	35
Chiavi combinate a cricchetto reversibili (8-9-10-12-13-14-15-16-17-18-19 mm)	519 M 285 KA	12
Chiavi combinate (6-7-8-9-10-12-13-14-15-16-17-18-19-22-24 mm)	519 M 285A1	17
Chiavi combinate (27-29-30-32-34 mm)	519 M 285A2	5
Chiave a rullino rapida e corta, pinza autobloccante e forbice	519 M 294B	4
Graviti per viti ad intaglio ed a croce PHILLIPS	519 M 324H	7
Graviti per viti TORX	519 M 324STX	8
Chiavi maschio esagonali con impugnatura (3-4-5-6-7-8-10 mm)	519 M 280HG	7
Cassella inserti assortita e chiavi maschio esagonali / TORX	519 M 280N1	11/
Pinze per anelli elastici interni ed esterni 15+25 e 19+60	519 M 127C	6
Pinza universale, pinza regolabile, tronchese, pinza becchi lunghi e pinza grip	519 M 150AX	5
Lime a taglio mezzodolce	519 M 990A5B	5
Martello per meccanici, mazzuola, cacciapigne, scalpello e bulino	519 M 382F	7

**495 PM**  
U04950630

**157**  
PEZZI

## Assortimento MANUTENZIONE - 4 cassette

DESCRIZIONE	ART	PZ
Bussole esagonali, cricchetto (237 A), accessori 1/4 ed inserti	519/613AEA	42
Bussole esagonali, cricchetto (237 A) ed accessori 1/2	519/613CEA	22
Chiavi combinate (6+24 mm) + chiavi maschio esagonali (1,5+10 mm)	519/285A1	25
Pinza universale, pinza regolabile, tronchese, pinza becchi lunghi e pinza grip	519/150AX	5
Graviti per viti ad intaglio ed a croce PHILLIPS	519/324H	10
Graviti per viti TORX	519/324TX	9
Lime a taglio mezzodolce	519/990A1	4
Martello per meccanici, mazzuola, cacciapigne, scalpello e bulino	519/382F	8
Assortimento di inserti con cricchetto reversibile	692 J32	32

~~€ 1.234,00~~
**€ 629,00**
**495 PA**  
U04950629

**142**  
PEZZI

## Assortimento AUTORIPARAZIONE - 2 cassette

DESCRIZIONE	ART	PZ
Bussole esagonali, cricchetto (237 A), accessori 1/4 ed inserti	519/613AEA	42
Bussole esagonali, cricchetto (237 A) ed accessori 1/2	519/613CEA	22
Graviti per viti ad intaglio ed a croce PHILLIPS	519/324H	10
Chiavi combinate (6+24 mm) + chiavi maschio esagonali (1,5+10 mm)	519/285A1	25
Pinza universale, pinza regolabile, tronchese, pinza becchi lunghi e pinza grip	519/150AX	5
Chiavi a T snodate con bocca esagonale (7-8-10-12-13-17 mm)	276 CE	6
Assortimento di inserti con cricchetto reversibile	692 J32	32

~~€ 1.148,00~~
**€ 629,00**

**NON TROVI IL TUO  
ASSORTIMENTO IDEALE?**
**Configuralo su [kitplanner.usag.it](http://kitplanner.usag.it)**

# Moduli in plastica



**519/127N**  
U05190716 **4 PEZZI**  
127 N 19+60 - 127 PN 19+60 -  
128 N 19+60 - 128 PN 19+60.  
~~€ 111,00~~ **€ 77,50**



**519/150AX**  
U05190850 **5 PEZZI**  
133 AX 160 - 134 250 - 150 AX 180 -  
180 C 250 - 188 AX 160.  
~~€ 163,00~~ **€ 114,00**



**519/280HG**  
U05191860 **7 PEZZI**  
280 HG 3-4-5-6-7-8-10.  
~~€ 109,00~~ **€ 76,50**



**519/280HGTS**  
U05191861 **7 PEZZI**  
280 HGTS 3-4-5-6-7-8-10.  
~~€ 119,00~~ **€ 83,50**



**519/285A1**  
U05190785 **25 PEZZI**  
285 6-7-8-9-10-11-12-13-14-15-16-17-  
18-19-22-24 280 S9 1,5-10.  
~~€ 184,00~~ **€ 129,00**



**519/285B2**  
U05190823 **4 PEZZI**  
285 27-29-30-32.  
~~€ 100,00~~ **€ 70,00**



**519/285KA1**  
U05190788 **12 PEZZI**  
285 KA 8-9-10-11-12-13-14-15-  
16-17-18-19.  
~~€ 236,00~~ **€ 165,00**



**519/294**  
U05190732 **9 PEZZI**  
204 250 - 294 A 250 - 367 2x110 - 3x130 -  
4x145 - 5x165 - 6x180 - 8x200 - 981 A3.  
~~€ 120,00~~ **€ 84,00**



**519/322H**  
U05190772 **10 PEZZI**  
322 0,5x3x75-0,8x4x100-1x5,5x125-  
1,2x6,5x150-1,6x8x175 - 322 PH 0x75-1x100-  
2x125 - 322 N 0,8x1x30 - 322 NPH 2x30.  
~~€ 62,00~~ **€ 43,40**



**519/322STX**  
U05190831 **6 PEZZI**  
322 STX T10-T15-T20-T25-T30-T40.  
~~€ 55,50~~ **€ 38,80**



**519/324H**  
U05190763 **10 PEZZI**  
324 0,5x3x75-0,8x4x100-1x5,5x125-  
1,2x6,5x150-1,2x8x200 - 324 PH 0x75-1x75-  
2x100 - 324 N 0,8x1x35 - 324 NPH 2x35.  
~~€ 80,50~~ **€ 56,50**



**519/324TX**  
U05190764 **9 PEZZI**  
324 TX T6x50-T7x50-T8x50-T9x75 - 324 STX  
T10x75-T15x75-T20x100-T25x100-T30x125.  
~~€ 106,00~~ **€ 74,00**



**519/366**  
U05190740 **7 PEZZI**  
351 200 - 362 125-150 - 364 125 -  
366 3x125 - 4x150 - 368 4x125.  
~~€ 80,00~~ **€ 56,00**



**519/382F**  
U05190742 **8 PEZZI**  
362 150 - 367 2x100-3x130-4x145-  
5x165 - 368 4x125 - 376 35 - 382F 500.  
~~€ 99,50~~ **€ 69,50**



**519/613AEA** ● **42 PEZZI**  
U05190784 237 A  
235 1/4" EN 4-4,5-5-5,5-6-7-8-9-10-11-12-13-  
14 - 236 1/4" 50-150 - 237 A 1/4" - 240 1/4" -  
241 1/4" - 243 1/4" - 602 S11 - 602 STX/S11 -  
684 1/4"-1/4".  
~~€ 203,00~~ **€ 146,00**



**519/613BEA** ● **21 PEZZI**  
U05190747 237 A  
235 3/8" E 6-7-8-9-10-11-12-13-14-15-  
16-17-18-19-21-22 - 236 3/8" 125-250 -  
237 A 3/8" - 240 3/8" N - 241 3/8".  
~~€ 213,00~~ **€ 149,00**



**519/613CEA** ● **22 PEZZI**  
U05190750 237 A  
235 1/2" EN 10-11-12-13-14-15-16-  
17-18-19-20-21-22-24-27-30-32 - 236  
1/2" 125-250 - 237 A 1/2" - 240 1/2" N -  
241 1/2".  
~~€ 257,00~~ **€ 180,00**



**519/990A1**  
U05190825 **4 PEZZI**  
990 M PA/200 - 990 M PB/200  
990 M PC/200 - 990 M PE/200.  
~~€ 57,50~~ **€ 40,30**



**519/280T**  
U05190727 **8 PEZZI XL**  
280 T 2-2,5-3-4-5-6-8-10.  
~~€ 155,00~~ **€ 109,00**



**Crea il tuo assortimento ideale su [kitplanner.usag.it](http://kitplanner.usag.it)**

**Scopri tutta la gamma di moduli in plastica su [usag.it](http://usag.it) o inquadra il QR code**



**519/276**  
U05190725 **8 PEZZI XXL**  
276 CE 7-8-10-11-13-14-17-19.  
~~€ 364,00~~ **€ 255,00**



**519 M 091A**  
U05191016 **8 PEZZI**  
091 0,5x3x75-0,8x4x100-1x5,5x125-1,2x6,5x150-091 PH 1x100-2x125-091 PZ 1x100-2x125.  
~~€ 94,50~~ **€ 66,00**



**519 M 280HGTS**  
U05191946 **7 PEZZI**  
280 HGTS 3-4-5-6-7-8-10.  
~~€ 125,00~~ **€ 87,50**



**519 M 285A2**  
U05190943 **5 PEZZI**  
285 27-29-30-32-34.  
~~€ 144,00~~ **€ 101,00**



**519 M 324H**  
U05190910 **8 PEZZI**  
324 0,5x3x75-0,8x4x100-1x5,5x125-1,2x6,5x150-324 PH 1x100-2x125-324 D 0,6x3,5x100-324 E 1,6x8x175.  
~~€ 76,50~~ **€ 53,50**



**519 M 613BEA** ● **20 PEZZI**  
U05190928 237 A  
235 3/8" E 7-8-9-10-11-12-13-14-15-16-17-18-19-21-22-236 3/8" 125-250-237 A 3/8" - 240 3/8" N - 241 3/8".  
~~€ 213,00~~ **€ 149,00**



**519 M 127N**  
U05190937 **4 PEZZI**  
127 N 19+60 - 127 PN 19+60 - 128 N 19+60 - 128 PN 19+60.  
~~€ 117,00~~ **€ 82,00**



**519 M 280N1**  
U05191013 **117 PEZZI**  
280 S9 1,5-2-2,5-3-4-5-6-8-10 - 280 TX/S8C T10-T15-T20-T25-T27-T30-T40-T45-692 J100.  
~~€ 139,00~~ **€ 93,00**



**519 M 285KA**  
U05190944 **12 PEZZI**  
285 KA 8-9-10-11-12-13-14-15-16-17-18-19.  
~~€ 241,00~~ **€ 169,00**



**519 M 324STX**  
U05190911 **7 PEZZI**  
324 STX T10x75-T15x75-T20x100-T25x100-T27x100-T30x125-T40x150.  
~~€ 107,00~~ **€ 75,00**



**519 M 613CEA** ● **23 PEZZI**  
U05190942 237 A  
235 1/2" EN 8-10-11-12-13-14-15-16-17-18-19-21-22-23-24-27-30-32 - 236 1/2" 125-250 - 237 A 1/2" - 240 1/2" N - 241 1/2".  
~~€ 269,00~~ **€ 188,00**



**519 M 150AX**  
U05190965 **5 PEZZI**  
133 AX 160 - 134 250 - 150 AX 180 - 180 C 250 - 188 AX 160.  
~~€ 169,00~~ **€ 118,00**



**519 M 280TK**  
U05190935 **6 PEZZI**  
280 TK 2,5-3-4-5-6-8.  
~~€ 125,00~~ **€ 90,00**



**519 M 285KB**  
U05191060 **12 PEZZI**  
285 KB 8-9-10-11-12-13-14-15-16-17-18-19.  
~~€ 104,00~~ **€ 129,00**



**519 M 382F**  
U05190926 **7 PEZZI**  
362 175 - 367 2x100-3x130-6x180-368 3x100 - 376 28 - 382F 500.  
~~€ 122,00~~ **€ 85,50**



**519 M 990A5MD**  
U05191011 **5 PEZZI**  
990 M PA/200 - 990 M PB/200 - 990 M PC/200 - 990 M PD/200 - 990 M PE/200.  
~~€ 76,00~~ **€ 53,00**

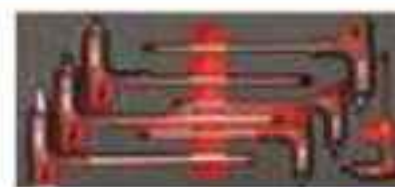

**519 M 280HG**  
U05191945 **7 PEZZI**  
280 HG 3-4-5-6-7-8-10.  
~~€ 115,00~~ **€ 80,50**



**519 M 285A1**  
U05190921 **17 PEZZI**  
285 6-7-8-9-10-11-12-13-14-15-16-17-18-19-21-22-24.  
~~€ 177,00~~ **€ 124,00**



**519 M 294B**  
U05191015 **4 PEZZI**  
135 A 250 - 207 E - 294 AC - 294 AD 250.  
~~€ 176,00~~ **€ 123,00**



**519 M 613AEA** ● **46 PEZZI**  
U05190940 237 A  
235 1/4" EN 5,5-6-7-8-9-10-11-12-13-14 - 236 1/4" 50-100 - 237 A 1/4" - 240 1/4" - 241 1/4" - 243 1/4" - 280 LTS/S9 - 684 1/4"-1/4" - 660 0,6-1-1,6 - 660 E 3-4-5-6-8 - 660 PH 1-2-3 - 660 PZ 1-2-3 - 660 STX T15-T20-T25-T27-T30-T40.  
~~€ 248,00~~ **€ 174,00**



Scopri tutta la gamma di moduli in spugna su [usag.it](http://usag.it) o inquadra il QR code



**8 PEZZI XL**  
**519 M 280T**  
U05191059  
280 T 2-2,5-3-4-5-6-8-10.  
~~€ 164,00~~ **€ 115,00**

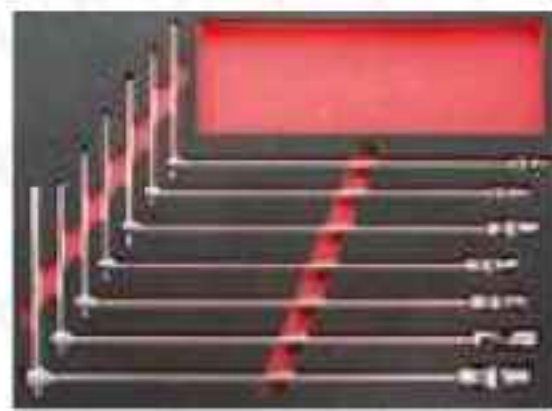

**7 PEZZI XXL**  
**519 M 276**  
U05190936  
276 CE 7-8-10-11-13-17-19.  
~~€ 340,00~~ **€ 248,00**

13 kg | 460 mm | 158 mm | 385 mm



## 002 JMA U00020011

### Valigia con assortimento per manutenzione

- Valigia con struttura in profilato di Alluminio.
- Doppia cerniera di chiusura in metallo con serratura.
- 3 pannelli portautensili interni con elastici di tenuta.
- Base con interno in spugna bicolore sagomata.

~~€ 728,00~~

**€ 419,00**



## PINZE SERIE AX, GIRAVITI 324 E CHIAVE A RULLINO 294 AD!

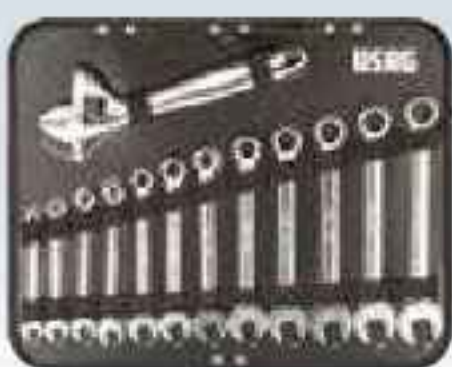

**181  
PEZZI**



## 002 JTMA U00020015

### Valigia trolley con assortimento per manutenzione

- Valigia con struttura in profilato di Alluminio.
- Doppia cerniera di chiusura in metallo con serratura.
- 3 pannelli portautensili interni con elastici di tenuta.
- Base con interno in spugna bicolore sagomata.

~~€ 728,00~~

**€ 439,00**



### RUOTE INTEGRATE NELLA STRUTTURA

14 kg | 485 mm | 200 mm | 377 mm







## 002 UDM

U00021706W

**Valigia con assortimento per manutenzione**

- Valigia con struttura in profilato di Alluminio.
- Doppia cerniera di chiusura in metallo con serratura.
- 3 pannelli portautensili interni con elastici di tenuta.
- Base con interno in mousse bicolore sagomata.

10 kg | 460 mm | 158 mm | 385 mm

74  
UTENSILI

~~€ 929,00~~

**€ 459,00**



**INSIEME  
UNICI**



## 002 UDE

U00022706W

**Valigia con assortimento per elettricisti**

74  
UTENSILI

10 kg | 460 mm | 158 mm | 385 mm

1000 V

~~€ 760,00~~

**€ 459,00**

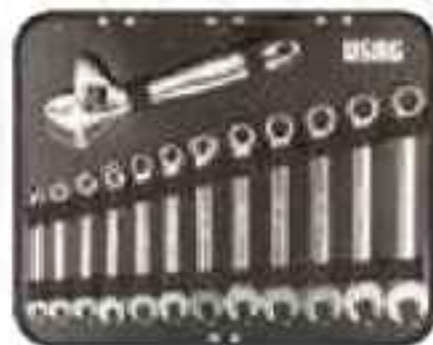

Modello con  
percussione



Batterie  
da 3.0 AH

## DCD706

**Trapano avvitatore a percussione**

- Coppia 57Nm.
- 0-425/1500 giri/minuto.
- Mandrino in metallo autoserrante 1-10mm.
- Caricabatterie rapido.

**12V XR**

**2 BATTERIE 12V  
3.0 AH INCLUSE**





420 mm

MAX  
11 kg

CAPACITÀ  
34 L

007/1V  
U00070001

2,5 kg | mm → 420  
↓ 340  
↙ 240



Tutta l'attrezzatura a portata di mano

### Borsa portautensili (vuota)

- Nylon ad altissima resistenza.
- Base rigida e resistente all'acqua.
- Pratici e comodi vani interni portautensili.
- Due tasche frontali portaminuteria.
- Pratico maniglione in alluminio.
- Ganci interni porta flessometro ed elastici portautensili.
- Mantella di chiusura tramite velcro.

~~€ 80,00~~

**€ 56,00**



490 mm

MAX  
15 kg

CAPACITÀ  
47 L

007 V  
U00070002

4 kg | mm → 490  
↓ 350  
↙ 220



Tasca frontale porta seghetto

### Borsa portautensili (vuota)

- Nylon ad altissima resistenza.
- Base rigida resistente all'acqua.
- Vani interni portautensili e tasca frontale porta seghetto.
- Maniglione in alluminio con impugnatura rivestita.
- Cinghia di trasporto a tracolla.
- Mantella di chiusura con velcro.

~~€ 104,00~~

**€ 73,00**



550 mm

MAX  
18 kg

CAPACITÀ  
33 L

007 TXV  
U00070065

5,4 kg | mm → 550  
↓ 440  
↙ 360



Maniglia telescopica

### Borsa trolley portautensili (vuota)

- Tessuto ad altissima resistenza
- Maniglia telescopica.
- Ruote con diametro 90 mm.
- 6 tasche esterne e 1 tasca frontale porta seghetto.
- Vani interni portautesili.
- Maniglione in alluminio con impugnatura rivestita.
- Mantella di chiusura con velcro.

~~€ 165,00~~

**€ 99,00**



Tasca frontale porta seghetto



Ruote con diametro 90 mm



MAX  
10 kg

CAPACITÀ  
15 L

**007 MCV**  
U00070008

1 kg | 360 mm | 280 mm | 190 mm

### Borsa portautensili (vuota)

- Tessuto ad altissima resistenza.
- Base rigida resistente all'acqua.
- Vani interni portautensili.
- 3 tasche frontali con mantella di protezione.
- 3 tasche posteriori.
- Maniglie con rivestimento in PVC.
- Cinghia di trasporto a tracolla.

~~€ 57,00~~

**€ 40,00**



MAX  
9 kg

CAPACITÀ  
8 L

**007 FLV**  
U00070007

470 g | 310 mm | 220 mm | 140 mm

### Borsa portautensili (vuota)

- Tessuto ad altissima resistenza.
- Tasca frontale con chiusura a cerniera.
- Tasca posteriore con chiusura a velcro.
- Base rigida rinforzata.
- Vani interni portautensili.
- Maniglie con rivestimento in PVC.

~~€ 29,00~~

**€ 20,00**



MAX  
25 kg

CAPACITÀ  
9 L

**007 PLV**  
U00070034

1,7 kg | 450 mm | 170 mm | 180 mm

### Borsa termoidraulico (vuota)

- Tessuto ad altissima resistenza.
- Base rigida rivettata per aumentare la resistenza al carico.
- Tasca portadocumenti interna.
- Può contenere un giratubi fino a 1 1/2".
- Gancio esterno ferma flessometro.
- Tracolla amovibile per un comfort extra nel trasporto.
- Due maniglie superiori per una migliore presa.
- Chiusura tramite velcro e fibbie a scatto con sgancio rapido.

~~€ 60,50~~

**€ 42,00**





MAX  
15 kg

CAPACITÀ  
8 L



L'apertura frontale consente un rapido accesso al contenuto.



007 RV  
U00070033

1,8 kg | 460 mm | 160 mm | 350 mm

### Borsa per utensili e PC (vuota)

- Tessuto ad altissima resistenza.
- Base rigida rinforzata.
- Può contenere Notebook di dimensioni L:340 mm - H:240 mm.
- 14 tasche, 2 cinghie portautensili e 1 gancio ferma flessometro.
- Tracolla amovibile per un comfort extra nel trasporto.
- Chiusura tramite fibbie a scatto con sgancio rapido.

~~€ 68,50~~

**€ 48,00**

MAX  
12 kg

CAPACITÀ  
30 L



Tasca porta Notebook o documenti



007 SV  
U00070004

3,1 kg | 355 mm | 225 mm | 460 mm

### Zaino portautensili (vuoto)

- Nylon ad altissima resistenza.
- Cinturino pettorale regolabile.
- Cinghie in vita imbottite.
- Base rigida resistente all'acqua.
- Vano interno portautensili.
- Portadocumenti interno.
- La tasca posteriore può contenere Notebook di dimensioni: L 340 mm - H 240 mm.

~~€ 97,50~~

**€ 69,00**



Tasca porta Notebook o documenti



007 TV  
U00070006

3,5 kg | 350 mm | 500 mm | 200 mm

### Trolley portautensili (vuoto)

- Dimensioni bagaglio a mano (cabin size).
- Tessuto ad altissima resistenza.
- Pratici e comodi vani interni portautensili.
- Tasca frontale portadocumenti.
- Tasche laterali con cinghie per il trasporto di oggetti lunghi.
- Asta telescopica in alluminio.
- Ruote integrate nella struttura.
- Bretelle posteriori per il trasporto a spalla.
- La tasca posteriore può contenere Notebook di dimensioni L:340 mm - H:240 mm.

~~€ 121,00~~

**€ 85,00**

MAX  
14 kg

CAPACITÀ  
30 L





**001 RV**  
U00010004

**Valigia porta utensili in polipropilene ad alto spessore (vuota)**

- Due pannelli interni amovibili con elastici portautensili.
- Vano inferiore con divisori amovibili e regolabili.
- Doppia serratura con chiave.

~~€ 293,00~~

**€ 205,00**



**001 TRV**  
U00010005

**Valigia trolley porta utensili in polipropilene ad alto spessore (vuota)**

- Maniglia telescopica in alluminio.
- Ruote con cuscinetto a sfera integrato.

~~€ 431,00~~

**€ 302,00**



**646/5LV**  
U06460301

**Cassetta estensibile LUNGA (vuota)**

- Predisposizione per lucchetto.
- Struttura in lamiera d'acciaio con verniciatura anaforetica.

~~€ 82,50~~

**€ 58,00**



**640 A**  
U06400001

**Organizer (vuoto)**

- Coperchio trasparente: visibilità istantanea del contenuto.
- 8 vaschette interne amovibili di cui 1 suddivisibile tramite 2 divisori in dotazione.

~~€ 32,00~~

**€ 22,40**



**641 T**

**Cassetta portautensili (vuota)**

- In materiale plastico ad alta resistenza.
- 2 scomparti portaminuteria sul coperchio.
- Possibilità di chiusura con lucchetto (non fornito).
- Vassoio interno amovibile.

	CODICE	L (mm)	P (mm)	H (mm)		
A	U06410004	16" 394	220	162	1,2 kg	<del>€ 23,60</del> <b>€ 16,50</b>
B	U06410005	19" 486	266	236	2,1 kg	<del>€ 35,40</del> <b>€ 24,80</b>
C	U06410006	24" 595	281	260	2,8 kg	<del>€ 47,20</del> <b>€ 33,00</b>



## GIRAVITE ELETTRICO 324 XP

LA VELOCITÀ DELLA BATTERIA, LA SENSIBILITÀ DEL TUO POLSO.



### ILLUMINAZIONE

a 5 LED frontali con autospegnimento a 10 secondi.



### PORTAINSERTI MAGNETICO

con ghiera a sgancio rapido.



IP54

### IMPUGNATURA

ergonomica in gomma resistente ad olii e prodotti chimici.

IEC 60529



### SISTEMA DI BLOCCAGGIO

automatico del mandrino per applicare la coppia a mano.



EN 60529

### GARANTISTICHE TECNICHE

Vibrazioni (mm/s <sup>2</sup> )	1,4
Potenza sonora dB(A)	54
Dimensioni (mm)	170x39
Peso (gr)	245



### LITHIUM

Batteria 3.6V al litio da 2 Ah.

<15%



15÷74%



75÷100%



### RICARICABILE

LED di indicazione dello stato di carica. Carica completa in 70 minuti (IN: 5V = 3A).



300  
Giri/min

0,9 Nm

## AVVITA LUI. STRINGI TU.

### LA SUA VELOCITÀ

Avvita e svita velocemente con i 300 giri/min del motore elettrico.

### LA TUA SENSIBILITÀ

Finisci il serraggio con la sensibilità di un giravite manuale.



10 Nm



Nylon ad alta resistenza



Elastici portainseriti



324 XP/B16

U03240801

16  
PEZZI

### Giravite elettrico in astuccio con inserti

- Astuccio in nylon ad alta resistenza.
- Elastici portainseriti.
- Tasca interna per il cavo USB-C.
- Gancio per cintura.

€ 242,00

€ 99,00



# GIRAVITI 324

## IL TOP DEL MERCATO.



**RIVESTIMENTO SOFT GRIP**  
Miglior comfort durante l'uso.  
Maggior trasmissione della coppia.

### IMPUGNATURA TRIMATERIALE

- 1 Esterno in poliuretano resistente ad oli ed agenti chimici.
- 2 Corpo in poliammide resistente agli sforzi.
- 3 Interno in poliammide ad alta densità per un perfetto accoppiamento alla lama.

### LAMA RINFORZATA

Acciaio al cromo silicio vanadio per la massima resistenza meccanica.

### PUNTA AL TOP

Finitura zincata. Geometria perfetta.  
Trattamento anti corrosione.

**GEOMETRIA ANTI-ROTOLOAMENTO**

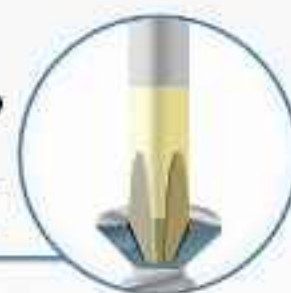

YouTube



### 324 SH5

U03240645

Serie di 5 giraviti per viti con intaglio e impronta a croce PHILLIPS®

- 324 D/0,8x4x100-1x5,5x125.
- 324 PH/0x75-1x75-2x100.

5 PEZZI



~~€ 34,80~~

**€ 24,40**



### 324 SH8

U03240650

Serie di 8 giraviti per viti con intaglio e impronta a croce PHILLIPS®

- 324 D/0,4x2,5x50.
- 324/0,5x3x75-0,8x4x100-1x5,5x125-1,2x6,5x150.
- 324 PH/0x75-1x75-2x100.

8 PEZZI



~~€ 52,00~~

**€ 33,00**



### 324 SH12

U03240651

Serie di 12 giraviti per viti con intaglio, impronta a croce PHILLIPS® e impronta a croce POZIDRIV® - SUPADRIV®

- 324 D/0,4x2,5x50.
- 324/0,5x3x75-0,8x4x100-1x5,5x125-1,2x6,5x150.
- 324 N/1x5,5x35.
- 324 PH/0x75-1x75-2x100.
- 324 NPH/2x35.
- 324 PZ/1x75-2x100.

12 PEZZI



~~€ 88,00~~

**€ 58,00**



### 324 STX/S7

U03240662

Serie di 7 giraviti con impronta TORX® Tamper Resistant

- 324 STX T10x75-T15x75-T20x100-T25x100-T27x100-T30x125-T40x150.

7 PEZZI



~~€ 95,00~~

**€ 61,00**

## GIRAVITI 322

### QUALITÀ E CONVENIENZA.



**322 SH7**  
U03220254

Serie di 7 giraviti per viti con intaglio e impronta a croce PHILLIPS®

- 322/I/0,4x2x50-0,5x3x75-0,8x4x100-1,5,5x100-1,2x6,5x150.
- 322 PH/1x100-2x125.

~~€ 36,40~~

**€ 25,50**



**322 SH10**  
U03220255

Serie di 10 giraviti per viti con intaglio, impronta a croce PHILLIPS® e impronta a croce POZIDRIV®

- 322/I/0,4x2x50-0,5x3x75-0,8x4x100-1x5,5x100-1,2x6,5x150.
- 322 PH/0x75-1x100-2x125.
- 322 PZ/1x100-2x125

~~€ 54,00~~

**€ 37,80**

## GIRAVITI 091

### ISOLATI 1000 V - EN 60900.

**USAG SLIM**



**091 D/SH5**  
U00910119

Serie di 5 giraviti SLIM per viti con intaglio e per viti con impronta a croce PHILLIPS®

- 091 D/0,6x3,5x100-0,8x4x100-1x5,5x125.
- 091 DPH/1x100-2x125.

~~€ 58,00~~

**€ 40,60**



**091 SH5**  
U00910100

Serie di 5 giraviti per viti con intaglio e per viti con impronta a croce PHILLIPS®

- 091/I/0,5x3x75-0,8x4x100-1x5,5x125.
- 091 PH/1x100-2x125.

~~€ 47,60~~

**€ 33,30**



**091 SH8**  
U00910106

Serie di 8 giraviti per viti con intaglio, per viti con impronta a croce PHILLIPS® e impronta a croce POZIDRIV® - SUPADRIV®

- 091/I/0,5x3x75-0,8x4x100-1x5,5x125-1,2x6,5x150.
- 091 PH/1x100-2x125.
- 091 PZ/1x100-2x125.

~~€ 82,00~~

**€ 57,00**





YouTube

**8**  
PEZZI  1/4

## CRICCHETTO INTEGRATO



## CRICCHETTO INTEGRATO



Fornito senza  
inserti USAG 660

**10**  
PEZZI  1/4

## 333 K/SH8

U03330142



### Assortimento COMBIDRIVE con inserti

- Fornito con una selezione di 6 inserti da 1/4".

DESCRIZIONE	ARTICOLO/MISURA	PZ
Impugnatura Combidrive	333 K	1
Lama portainseriti magnetica	333 1/4 MG	1
Inserti ad intaglio	660/0,6x4,5-1x5,5	2
Inserti a croce PH	660 PH 1-2	2
Inserti esagonali	660 E 3-4	2

~~€ 61,00~~

**€ 41,30**

## 333 K/SB10

U03330143



### Assortimento COMBIDRIVE in astuccio di nylon

- Fornito con una selezione di lame.
- Include un astuccio da cintura in nylon.

DESCRIZIONE	ARTICOLO/MISURA	PZ
Impugnatura Combidrive	333 K	1
Lama portainseriti magnetica	333 1/4 MG	1
Lame reversibili ad intaglio	333 I 0,6x3,5-0,8x4/1x5,5-1,2x6,5	2
Lame reversibili a croce PH	333 PH 0-1/2-3	2
Lame reversibili TORX®	333 TX T8-T9 333 STX T10-T15/T20-T25/T30-T40	4

~~€ 108,00~~

**€ 73,00**

## 280 TQ

U02800800

### Chiave a T portainseriti

- Doppio portainseriti esagonale magnetico da 1/4".
- Capacità massima del portainseriti: inserto per viti esagonali incassate misura 6 mm oppure viti Torx misura T40.
- Estremità con quadro portabussole da 1/4".
- Acciaio speciale altamente legato al cromo vanadio.
- Esecuzione cromata.

~~€ 37,00~~

**€ 25,90**



YouTube

**210 mm**  
di lunghezza





YouTube

## CHIAVI MASCHIO 280 T SICUREZZA GARANTITA.



**ACCIAIO SPECIALE**  
al cromo vanadio.



**CHIAVI USAG**



**ALTRE CHIAVI**

### SICUREZZA GARANTITA

- +30% resistenza alla torsione rispetto alla norma ISO 2936.
- Raggiunta la coppia di rottura, la chiave si deforma senza spezzarsi.

### TRAVERSINO FISSO

Massima resistenza.



**7**  
PEZZI



**280 T/SE7**  
U02800903

Serie di 7 chiavi a T con maschio esagonale

- 280 T/2-2,5-3-4-5-6-8 mm.

~~€ 119,00~~

**€ 83,50**

**8**  
PEZZI



**280 TTX/SE8**  
U02800686

Serie di 8 chiavi a T per viti con impronta TORX®

- 280 TTX/T6-T7-T8-T9-T10-T15-T20-T25.

~~€ 169,00~~

**€ 119,00**

**6**  
PEZZI



**280 TTS/SE6**  
U02800760

Serie di 6 chiavi a T maschio esagonali con testa sferica

- 280 TTS/2,5-3-4-5-6-8 mm.

~~€ 105,00~~

**€ 73,00**



**Testa sferica**

**6**  
PEZZI



**280 TK/SE6**  
U02800020

Serie di 6 chiavi a T maschio esagonale con traversino scorrevole

- 280 TK/2,5-3-4-5-6-8 mm.

~~€ 113,00~~

**€ 79,00**



**Traversino scorrevole**

## CHIAVI MASCHIO 280 HG CON IMPUGNATURA ERGONOMICA.



### SICUREZZA GARANTITA

- +30% resistenza alla torsione rispetto alla norma ISO 2936.
- Raggiunta la coppia di rottura, la chiave si deforma senza spezzarsi.

Stessa lama  
delle chiavi 280 T

IMPUGNATURA BIMATERIALE  
ERGONOMICA.

ACCIAIO SPECIALE  
AL CROMO VANADIO.



6  
PEZZI



**280 HG/SE6**  
U02801460

Serie di 6 chiavi maschio  
esagonale con impugnatura

- 280 HG/2,5-3-4-5-6-8 mm.

~~€ 79,00~~

**€ 55,00**

6  
PEZZI



**280 HGTS/SE6**  
U02801463

Serie di 6 chiavi maschio esagonale  
a testa sferica con impugnatura

- 280 HGTS/2,5-3-4-5-6-8 mm.

~~€ 87,00~~

**€ 61,00**

Testa  
sferica



6  
PEZZI



**280 HAP/SE6**  
U02800462

Serie di 6 chiavi maschio  
esagonale in pollici con impugnatura

- 280 HAP/1/4-7/32-5/32-5/16-3/8-3/16".

~~€ 78,00~~

**€ 54,50**

6  
PEZZI



**280 HATX/SE6**  
U02800464

Serie di 6 chiavi maschio  
con impugnatura per viti con  
impronta TORX®

- 280 HATX/T8-T10-T15-T20-T25-T30.

~~€ 61,00~~

**€ 42,70**

# Inserti e chiavi maschio



**32**  
PEZZI



280 g | mm | 138  
30  
98



YouTube



**692 J32**

**U06920042**

## Assortimento di inserti con cricchetto

DESCRIZIONE	MISURA	PZ.
Inserti ad intaglio	4-5,5-6,5-8	4
Inserti a croce PHILLIPS®	PH 1-2-3	3
Inserti a croce POZIDRIV®	PZ 1-2-3	3
Inserti esagono maschio	3-4-5-6	4
Inserti TORX®	T8-10-15-20-20-25-25-30-40	9
Inserti TORX® Tamper Resistant	STX 10-15-20-25-27-30-40	7
Portainseri magnetico		1
Cricchetto		1

~~€ 55,00~~

**€ 38,50**



**49**  
PEZZI



280 g | mm | 138  
30  
98

**692 J49**

**U06920041**

## Assortimento di inserti

DESCRIZIONE	MISURA	PZ.
Inserti ad intaglio	4-4,5-5,5-6,5-6,5-8	6
Inserti a croce PHILLIPS®	PH 1-1-2-2-2-3	6
Inserti a croce POZIDRIV®	PZ 1-1-2-2-2-3-3	7
Inserti esagono maschio	2-3-3-4-4-5-5-6-6	9
Inserti TORX®	TX 10-10-15-15-20-20-25-25-30-30	10
Inserti TORX® Tamper Resistant	STX 10-15-15-20-20-25-25-30-30-40	10
Portainseri magnetico		1

~~€ 42,60~~

**€ 29,80**



Riconoscimento dell'inserto con codice colore per una scelta rapida



50 mm



**664 S25**

**U06640111**

**25**  
PEZZI

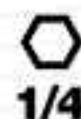

800 g | mm | 215  
45  
150

## Assortimento di inserti per avvitatura

- Fornito in cassetta di plastica

DESCRIZIONE	MISURA	PZ.
Inserti lunghi ad intaglio	3-4-5-6	4
Inserti lunghi a croce PH	1-2(x2)-3(x1)	5
Inserti lunghi a croce PZ	1-2(x2)-3(x1)	5
Inserti lunghi TORX®	T15-T20-T25-T30-T40	5
Inserti lunghi esagonali	2-3-4-5-5,5	5
Portainseri magnetico		1

~~€ 68,50~~

**€ 47,90**

**664 B/S7**

**U06640015**

## Assortimento di inserti a bussola

- Fornito in cassetta di plastica

~~€ 36,70~~

**€ 25,70**



**7**  
PEZZI



**5,5-6-7-8**  
**10-12-13 mm**

300 g | mm | 138  
30  
98





900 g | 215 mm | 45 mm | 150 mm

DESCRIZIONE	MISURA	PZ.
Inserti a intaglio	3-4-4,5-5-5,5-6-6,5-7-8	9
Inserti a croce	PH 00-0-1-1-2-2-3-4 PZ 1-2-2-3-4	13
Inserti esagono maschio	1,5-2-2,5-3-4-5-5,5-6-7-8 mm 1/16-5/64-3/32-7/64-1/8-9/64-5/32-3/16-7/32-1/4"	20
Inserti TORX®	T 8-9-10-15-20-25-27-30-40-45	10
Inserti TORX® Tamper Resistant	STX 8-10-15-20-25-27-30-35-40	9
Inserti Tri-Wing	1-2-3-4	4
Inserti Spanner	4-6-8-10-12	5
Inserti Torq-set	6-8-10	3
Inserti quadrati	0-1-2-2-3	5
Inserti Clutch	1/8-5/32-3/16-1/4-5/16	5
Inserti XZN	M5-M6-M8	3
Inserti esagono maschio con foro	2-2,5-3-4-5-6 mm - 5/64-3/32-7/64-1/8-9/64-5/32"	12
Portainseri magnetici	1/4x60mm	2

**692 J100**  
U06920043

Assortimento di inserti con impronte speciali

~~€ 65,50~~

**€ 45,80**

100 PEZZI

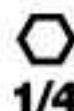

**SUPPORTI COMPATTI CON SISTEMA DI ESTRAZIONE RAPIDA**



Guarda il video dimostrativo



YouTube



9 PEZZI



**280 LTS/S9**  
U02800084

Serie di 9 chiavi maschio esagonale lunghe testa sferica

• 280 LTS/1,5-2-2,5-3-4-5-6-8-10 mm.

~~€ 33,90~~

**€ 21,50**



8 PEZZI



**280 LTSTX/S8**  
U02800078

Serie di 8 chiavi maschio lunghe testa sferica TORX®

• 280 LTSTX/T10-T15-T20-T25-T27-T30-T40-T45.

~~€ 61,50~~

**€ 43,00**



9 PEZZI



**280 XLTS/S9**  
U02800184

Serie di 9 chiavi maschio esagonale extra-lunghe a testa sferica

• 280 XLTS/1,5-2-2,5-3-4-5-6-8-10 mm.

~~€ 37,60~~

**€ 26,40**

## GAMMA PINZE "AX"

### FINITURA CROMATA ED IMPUGNATURE BIMATERIALE.



Taglia fino a Ø 2 mm di filo armonico con il 30% in meno di forza rispetto al valore massimo indicato dalle normative europee ISO5749 (tronchesi) - ISO5746 (pinze).

YouTube



**TAGLIENTI TEMPRATI AD INDUZIONE**  
per la massima efficacia nel taglio del filo armonico.



**FULCRO PIÙ VICINO AI TAGLIENTI**  
per il minimo sforzo durante il taglio.

**IMPUGNATURE ERGONOMICHE BIMATERIALE**

IMPUGNATURA USAG

PRODOTTI SUL MERCATO



- SFORZO

+ SFORZO

Minimo sforzo risultante dagli studi sugli sforzi muscolari effettuati dal prestigioso istituto americano US Ergonomics.

3 PEZZI



**150 AX/SE3**

U01500201

**Assortimento pinze e tronchesi**

- Pinza universale 150 AX 180.
- Pinza a becchi mezzotondi lunghissimi dritti 133 AX 160.
- Tronchese a grande effetto a tagliente diagonale 188 AX 160.

€ 96,50

**€ 68,00**

3 PEZZI



**085 EX/SE3**

U00850121

**Assortimento pinze e tronchesi isolati 1000 V**

- Pinza universale 085 EX 180.
- Pinza a becchi mezzotondi lunghissimi dritti 081 EX 160.
- Tronchese a grande effetto a tagliente diagonale 087 EX 160.

€ 130,00

**€ 91,00**

**1000 V**



**PROFILI TONDI**

intaglio ricavato nella dentatura per una presa sicura di barre tonde, anche filettate.



**PROFILI ESAGONALI**

Geometria delle ganasce studiata per la presa di un esagono.



**155 AX**

U01550001

**Pinza universale multifunzione**

€ 59,50

**€ 39,00**

**Pinza multifunzione**



**CAPACITÀ MAX.**  
**80 mm**

**135 B**

**U01350510**

**Pinza regolabile autobloccante a cremagliera con ganasce lunghe**

- Ganasce forgiate.
- Dentatura studiata per una presa perfetta anche su tondo.
- Sistema di apertura brevettato ed integrato nei manici.
- Rullino di regolazione della presa integrato sul manico superiore.
- Cremagliera a 5 posizioni.

~~€ 75,50~~

**€ 53,00**



**CAPACITÀ MAX.**  
**135 mm**

**135 C**

**U01350530**

**Pinza regolabile autobloccante a cremagliera a grande capacità**

- Ganasce forgiate.
- Dentatura studiata per una presa perfetta anche su tondo.
- Sistema di apertura brevettato ed integrato nei manici.
- Rullino di regolazione della presa integrato sul manico superiore.
- Cremagliera a 5 posizioni.

~~€ 92,00~~

**€ 64,00**



**TAGLIO RASO**



**PER MATERIALE PLASTICO**

**186 C**

**Tronchesi a tagliente raso diagonale per materiali plastici**

- Becchi arrotondati ribassati.
- Molla di richiamo.
- Manici rivestiti con guaina in PVC.
- Corpo in acciaio speciale altamente legato al cromo vanadio.
- Esecuzione brunita testa pulita.

CODICE	L	TAGLIENTI
--------	---	-----------

U01860060	150 mm	22 mm
-----------	--------	-------

~~€ 38,50~~

**€ 23,90**

U01860061	180 mm	27 mm
-----------	--------	-------

~~€ 43,90~~

**€ 27,30**



**TAGLIO RASO PIEGATO A 45°**



**PER MATERIALE PLASTICO**

**187 C**

**U01870001**

**Tronchese a tagliente raso diagonale piegato a 45° per materiali plastici**

- Becchi arrotondati ribassati.
- Molla di richiamo.
- Manici rivestiti con guaina in PVC.
- Corpo in acciaio speciale altamente legato al cromo vanadio.
- Esecuzione brunita testa pulita.

~~€ 58,00~~

**€ 40,50**

**PERFETTI PER IL TAGLIO PIANO E A FILO DELLE SUPERFICI DELLE MATEROZZE, TIPICO DELLO STAMPAGGIO A INIEZIONE**

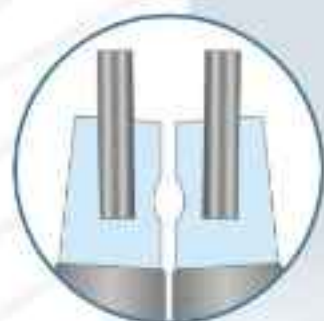

## MASSIMA RESISTENZA

Punte in acciaio armonico inserite nei becchi.



**127 N/SE4S**  
U01270046

**10÷25 mm**

**Serie 4 pinze per anelli elastici**

- Pinze per anelli elastici interni **127 N** 12÷25-**127 PN** 12÷25.
- Pinze per anelli elastici esterni **128 N** 10÷25-**128 PN** 10÷25.

~~€ 97,50~~

**€ 68,50**

**127 N/SE4**  
U01279000P

**19÷60 mm**

**Serie 4 pinze per anelli elastici**

- Pinze per anelli elastici interni **127 N** 19÷60-**127 PN** 19÷60.
- Pinze per anelli elastici esterni **128 N** 19÷60-**128 PN** 19÷60.

~~€ 106,00~~

**€ 74,00**

**127 C/SE4S**  
U01270045

**10÷25 mm**

**Serie 4 pinze per anelli elastici**

- Pinze per anelli elastici interni **127 C** 12÷25-**127 CP** 12÷25.
- Pinze per anelli elastici esterni **128 C** 10÷25-**128 CP** 10÷25.

~~€ 81,00~~

**€ 56,50**

**127 C/SE4**  
U01270040

**19÷60 mm**

**Serie 4 pinze per anelli elastici**

- Pinze per anelli elastici interni **127 C** 19÷60-**127 CP** 19÷60.
- Pinze per anelli elastici esterni **128 C** 19÷60-**128 CP** 19÷60.

~~€ 88,50~~

**€ 62,00**



## MASSIMA ACCESSIBILITÀ

Punte e becchi in corpo unico.

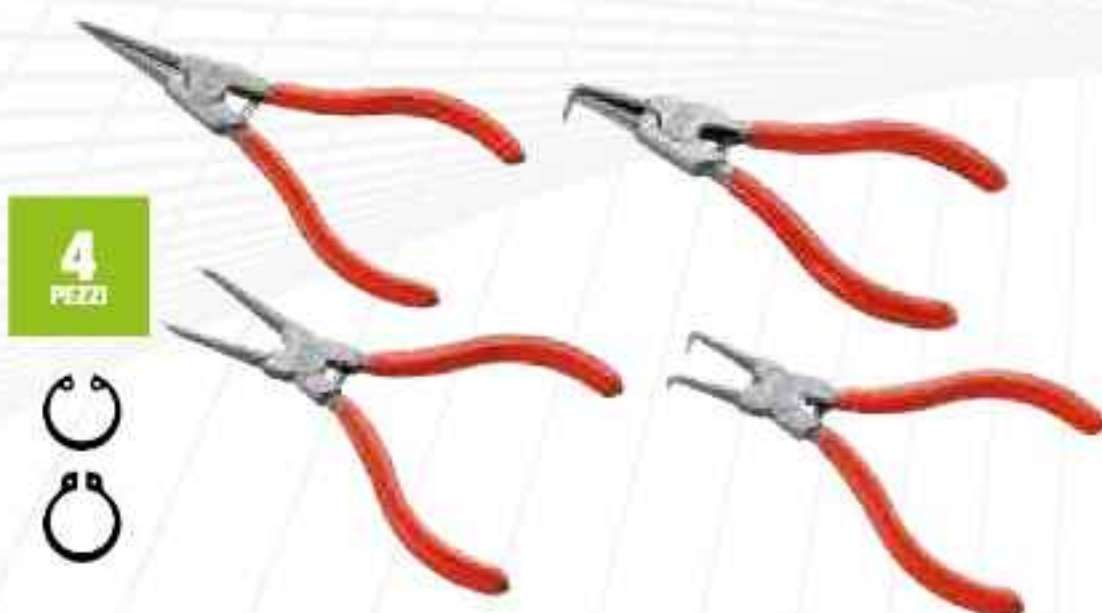

**127 C/SE4P**  
U01270060

*Novità*

**3÷10 mm**

**Serie 4 pinze per anelli elastici**

- Pinze per anelli elastici interni **127 C** 3÷10-**127 CP** 3÷10.
- Pinze per anelli elastici esterni **128 C** 3÷10-**128 CP** 3÷10.

~~€ 81,00~~

**€ 56,50**

**127 C/SE4M**  
U01270065

*Novità*

**40÷100 mm**

**Serie 4 pinze per anelli elastici**

- Pinze per anelli elastici interni **127 C** 40÷100-**127 CP** 40÷100.
- Pinze per anelli elastici esterni **128 C** 40÷100-**128 CP** 40÷100.

~~€ 112,00~~

**€ 78,50**



# PINZE A CREMAGLIERA PER ANELLI ELASTICI

**MECCANISMO A CREMAGLIERA**  
che consente di rimuovere o installare senza sforzo e con precisione, anelli elastici di grandi dimensioni

**FINITURA CROMATA**

**MANICI RIVESTITI IN PVC**

**85÷200 mm**

**PUNTE RIMOVIBILI E INTERCAMBIABILI**  
fissate tramite grano con esagono da 5 mm

**Novità**

**Novità**

**127 M**  
U01270051

Pinza a cremagliera a becchi dritti per anelli elastici interni di grandi dimensioni

€ 80,00 **€ 56,00**

310 mm

**Novità**

**127 MP**  
U01270050

Pinza a cremagliera a becchi piegati a 45° per anelli elastici interni di grandi dimensioni

€ 80,00 **€ 56,00**

310 mm

**Novità**

**128 M**  
U01280051

Pinza a cremagliera a becchi dritti per anelli elastici esterni di grandi dimensioni

€ 80,00 **€ 56,00**

310 mm

**Novità**

**128 MP**  
U01280050

Pinza a cremagliera a becchi piegati a 45° per anelli elastici esterni di grandi dimensioni

€ 80,00 **€ 56,00**

310 mm

## PINZA CHIAVE 174 CX PINZA E CHIAVE IN UN UNICO UTENSILE.



**SISTEMA  
DI CHIUSURA RAPIDA**  
senza premere il pulsante.



**BECCHI PIATTI E PARALLELI**  
Battuta sagomata  
per far presa su 4 lati dell'esagono.



**GANASCE SOTTILI**

**CAPACITÀ MAX.  
58 mm**



 YouTube

**SCALA MILLIMETRATA**

**CREMAGLIERA CON  
20 POSIZIONI**

**MANICI RIVESTITI  
IN PVC**

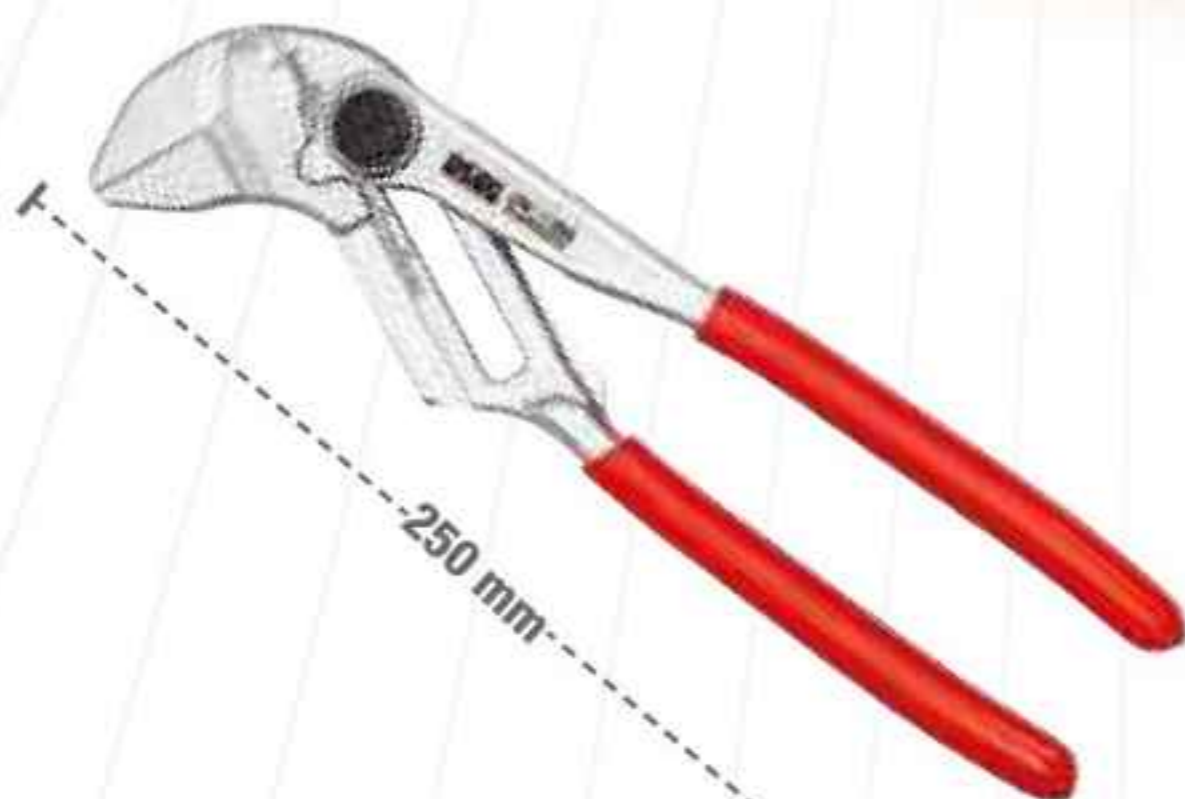

**174 CX**  
U01740001

**Pinza chiave regolabile**

- Lunghezza 250 mm.

€ 74,00

**€ 52,00**

**APERTURA  
MAGGIORATA +20%**



YouTube



**ARRETRI IL RULLINO,  
REGOLI RAPIDAMENTE.**

**RUOTI IL RULLINO,  
REGOLI CON PRECISIONE.**

**APERTURA  
MAGGIORATA +20%**



YouTube



**POSIZIONE  
STANDARD**

**GANASCIA  
INVERTITA**

**INVERTI**

**LA GANASCIA MOBILE**  
per passare dalla presa su  
esagono a quella su tondo.



**APERTURA  
MAX 34 mm**

**Solo 150 mm**



**LUNGHEZZA RIDOTTA  
DEL 46% RISPETTO AD  
UNA CHIAVE STANDARD**

## 294 AD

### Chiavi a rullino con regolazione rapida

- Si regola rapidamente arretrando il rullino.
- Grande capacità: apertura +20% rispetto allo standard.
- Doppia scala graduata: millimetri e pollici.
- Testa inclinata di 22°.
- Rullino in acciaio.
- Asola di aggancio.
- Finitura cromata.

CODICE	L	APERTURA	<del>€</del>	€
U02940011	110 mm - 4"	17 mm	<del>€19,90</del>	<b>€ 13,50</b>
U02940012	150 mm - 6"	23 mm	<del>€20,90</del>	<b>€ 14,20</b>
U02940013	200 mm - 8"	33 mm	<del>€24,20</del>	<b>€ 17,00</b>
U02940014	250 mm - 10"	38 mm	<del>€30,70</del>	<b>€ 21,50</b>
U02940015	300 mm - 12"	41 mm	<del>€40,40</del>	<b>€ 28,30</b>
U02940016	380 mm - 15"	50 mm	<del>€74,00</del>	<b>€ 52,00</b>
U02940017	460 mm - 18"	63 mm	<del>€122,00</del>	<b>€ 85,50</b>

## 294 AG

### Chiavi a rullino reversibili con impugnatura

- Nella posizione standard può manovrare un profilo esagonale.
- Invertendo il dente mobile, può manovrare un profilo tondo.
- Grande capacità: apertura +20% rispetto allo standard.
- Doppia scala graduata: millimetri e pollici.
- Impugnatura ergonomica bimatériauale.
- Testa inclinata di 22°.
- Rullino in acciaio.
- Asola di aggancio.
- Finitura cromata.

CODICE	L	APERTURA	<del>€</del>	€
U02940023	200 mm - 8"	33 mm	<del>€26,50</del>	<b>€ 18,60</b>
U02940024	250 mm - 10"	38 mm	<del>€33,00</del>	<b>€ 23,60</b>
U02940025	300 mm - 12"	41 mm	<del>€44,40</del>	<b>€ 31,10</b>

## 294 AC

U02940010

### Chiave regolabile a rullino corta

- Lunghezza ridotta del 46% rispetto ad una chiave standard.
- Apertura ganasce pari ad una chiave a rullino da 12".
- Leggera e compatta per un'ottima accessibilità.
- Regolazione tramite rullino in acciaio.
- Scala millimetrata sulla testa della chiave.
- Finitura cromata.

~~€24,10~~

**€ 16,90**

## CHIAVE A CRICCHETTO 285 KA CON ANELLO DI TENUTA INTEGRATO.



### SEZIONE A DOPPIA T

Massima resistenza  
alla flessione.

### ANELLO IN ACCIAIO ARMONICO INTEGRATO NELL'OCCHIO POLIGONALE

Mantiene la posizione sul dado  
durante la manovra.

### POSIZIONE OTTIMALE



### FORCHETTA CON SISTEMA ANTISLITTAMENTO DEL DADO

Maggiore tenuta durante la manovra.

### CRICCHETTO RESISTENTE

Resistenza alla torsione statica del cricchetto:  
**+50% rispetto alla norma ISO 1711-1.**



YouTube

8  
PEZZI

8÷19 mm



285 KA/DS8

U02856058

Serie di 8 chiavi combinate a cricchetto  
con anello di tenuta

- 285 KA/8-10-11-12-13-14-17-19 mm.
- Fornita con supporto in plastica.

~~€ 157,00~~

**€ 105,00**

12  
PEZZI

7÷19 mm



285 KA/DS12

U02856062

Serie di 12 chiavi combinate a cricchetto  
con anello di tenuta

- 285 KA/7-8-10-11-12-13-14-15-16-17-18-19 mm.
- Fornita con supporto in plastica.

~~€ 238,00~~

**€ 167,00**

## CHIAVE A CRICCHETTO SNODATA 285 KF



**5 PEZZI**  **8÷19 mm**

**285 KF/SE5**  
**U02856160**

Serie di 5 chiavi combinate a cricchetto snodate

- 285 KF/8-10-13-17-19 mm.

~~€ 111,00~~ **€ 77,50**



**8 PEZZI**  **8÷19 mm**

**285 KF/DS8**  
**U02856158**

Serie di 8 chiavi combinate a cricchetto snodate

- 285 KF/8-10-11-12-13-14-17-19 mm.
- Fornita con supporto in plastica.

~~€ 184,00~~ **€ 129,00**

## CHIAVE A CRICCHETTO PIATTA 285 KB



**7 PEZZI**  **8÷19 mm**

**285 KB/DS7**  
**U02856341**

Serie di 7 chiavi combinate a cricchetto piatte

- 285 KB/8-10-12-13-14-17-19 mm.
- Fornita con supporto in plastica.

~~€ 108,00~~ **€ 75,00**



**12 PEZZI**  **8÷19 mm**

**285 KB/DS12**  
**U02856342**

Serie di 12 chiavi combinate a cricchetto piatte

- 285 KB/8-9-10-11-12-13-14-15-16-17-19 mm.
- Fornita con supporto in plastica.

~~€ 185,00~~ **€ 127,00**



YouTube

## CHIAVE COMBINATA 285 RESISTENTE ED ERGONOMICA.



### FORCHETTA INCLINATA

Angolo di 15° rispetto all'asse della chiave.

### SEZIONE A DOPPIA T

Massima resistenza alla flessione.



### OCCHIO DISASSATO

Per dadi e bulloni incassati in posizioni di difficile accesso.



### TOP PERFORMANCE

Resistenza alla torsione statica di anello e forchetta: **+50%** rispetto alla norma ISO 1711-1.

**ISO 1711-1**  
**SAE AS 954E**

8÷19 mm

8  
PEZZI

**285 DS8**  
U02850863

**Serie di 8 chiavi combinate**  
• 285/8-10-11-12-13-14-17-19 mm.  
• Fornita con supporto in plastica.

~~€ 78,50~~

**€ 51,00**

7÷19 mm

12  
PEZZI

**285 DS12**  
U02850864

**Serie di 12 chiavi combinate**  
• 285/7-8-10-11-12-13-14-15-16-17-18-19 mm.  
• Fornita con supporto in plastica.

~~€ 116,00~~

**€ 79,00**

MISURE  
IN POLLICI

1/4÷9/16"



5  
PEZZI

**285 P/SE5**  
U02850856

**Serie di 26 chiavi combinate in pollici**  
• 285 P/ 1/4-3/8-7/16-1/2-9/16".

~~€ 45,40~~

**€ 31,00**



26  
PEZZI

**285 SE26**  
U02850861

**Serie di 26 chiavi combinate**  
• 285/6-7-8-9-10-11-12-13-14-15-16-17-18-19-20-21-22-23-24-25-26-27-28-29-30-32 mm.

~~€ 347,00~~

**€ 236,00**

**XGRIP**

**VITI O DADI SPANATI?  
NON BESTEMMIARE!**

Vai a pagina 4: abbiamo la soluzione per te!

Just **USAG**

## CHIAVE COMBINATA 285 J



**FORCHETTA INCLINATA DI 15°**



**TESTA POLIGONALE PIEGATA DI 15°**

**7 PEZZI**

**8÷19 mm**

**285 J/DS7**  
U02851745

- Serie di 7 chiavi combinate**
- 285 J/8-10-12-13-14-17-19 mm.
  - Fornita con supporto in plastica.

~~€ 56,00~~

**€ 39,00**

**12 PEZZI**

**8÷19 mm**

**285 J/DS12**  
U02851746

- Serie di 12 chiavi combinate**
- 285 J/8-9-10-11-12-13-14-15-16-17-19 mm.
  - Fornita con supporto in plastica.

~~€ 93,00~~

**€ 59,00**

**8 PEZZI**

**6÷22 mm**



**252 N/SR8**  
U02520862

- Serie di 8 chiavi a forchetta doppie**
- 252 N/6x7-8x9-10x11-12x13-14x15-16x17-18x19-20x22 mm.

~~€ 60,00~~

**€ 42,20**

**8 PEZZI**

**7÷19 mm**

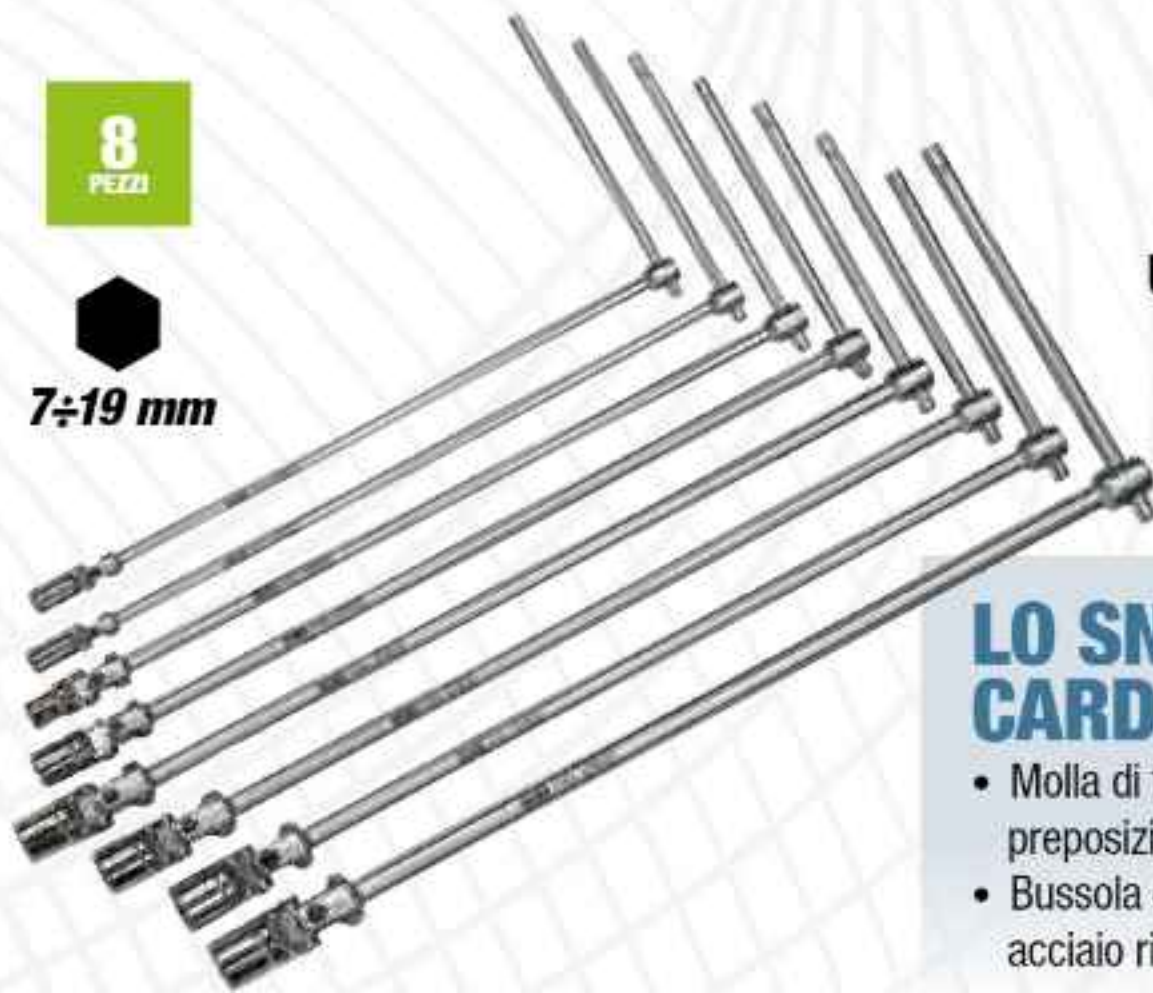

**UNI 6743**

**276 CE/SE8**  
U02760484

- Serie di 8 chiavi a T snodate**
- 276 CE/7-8-10-12-13-14-17-19 mm.

~~€ 352,00~~

**€ 245,00**

### LO SNODO CARDANICO USAG

- Molla di frizione interna per il perfetto preposizionamento della bussola.
- Bussola e cardano fissati con un perno in acciaio ribadito per la massima affidabilità.





16  
PEZZI

1/4"

1/2"



1 kg | mm | 190  
58  
144

## 601 1/4-1/2" JTX16

U06010009

Assortimento in cassetta modulare con bussole TORX®

DESCRIZIONE	MISURA	PZ.
Chiavi a bussola 1/4 TORX®	E6-E7-E8-E10	4
Chiavi a bussola 1/2 TORX®	E12-E14-E16-E18	4
Chiavi a bussola 1/4 con inserto TORX®	T10-T15-T20-T25	4
Chiavi a bussola 1/2 con inserto TORX®	T30-T40-T45-T50	4

~~€ 41,00~~

**€ 28,80**



34  
PEZZI

1/4"



1 kg | mm | 190  
58  
144

## 601 1/4" J34

U06010001

Assortimento in cassetta modulare con bussole esagonali ed inserti per avvitatura

DESCRIZIONE	MISURA	PZ.
Chiavi a bussola 1/4"	4-4,5-5-5,5-6-7-8-9-10-11-12-13-14	13
Cricchetto reversibile 1/4"		1
Snodo cardanico 1/4"		1
Prolunghe 1/4"	55-100	2
Inserti a intaglio	4-5,5-6	3
Inserti a croce POZIDRIV®	1-2-3	3
Inserti esagono maschio	4-5-6	3
Inserti TORX®	T10-T15-T20-T25-T30-T40	6
Impugnatura maschio/femmina		1
Raccordo portainseriti 1/4"		1

~~€ 66,50~~

**€ 46,00**



22  
PEZZI

1/2"



4 kg | mm | 375  
80  
186

## 601 1/2" J22

U06010003

Assortimento in cassetta modulare con bussole esagonali

DESCRIZIONE	MISURA	PZ.
Bussole esagonali 1/2"	8-10-11-12-13-14-15-16-17-18-19-21-22-24-27-30-32	17
Cricchetto 1/2"		1
Prolunghe 1/2"	130-250	2
Snodo cardanico 1/2"		1
Leva a T 1/2"		1

~~€ 116,00~~

**€ 75,00**



LA QUALITÀ **USAG** A UN PREZZO *Just*





1/4"  
1/2"

8 kg | 415 mm | 92 | 283

100 PEZZI



601 1/4-1/2" J100  

U06010011

Assortimento in cassetta modulare con bussole esagonali ed inserti per avvitatura

€ 192,00

**€ 129,00**

Modulare con i cassettei dei carrelli USAG!



1/4"  
1/2"

7 kg | 415 mm | 92 | 283

82 PEZZI



601 1/4-1/2" J82 

U06010010

Assortimento in cassetta modulare con bussole esagonali e chiavi combinate

€ 291,00

**€ 149,00**

Modulare con i cassettei dei carrelli USAG!



## CRICCHETTO 237 A CON MECCANISMO SIGILLATO IP51.



Sistema di inversione integrato nel coperchio



Spessore della testa ridotto rispetto ai modelli standard



YouTube



**IMPUGNATURA CONICA**  
in bimateriale e antiscivolo.



1. Nottolino brevettato.  
2. Diaframma protettivo.

### TOP PERFORMANCE

1. Resistenza alla torsione statica: +30% di coppia rispetto alla norma ISO 3315 grazie al nottolino brevettato.
2. Resistenza a fatica: dura il doppio dei normali cricchetti del mercato grazie alla protezione IP51.



23 PEZZI

1 1/2"



3 kg | 330 mm | 215

606 1/2" EA  
U06060302

**Assortimento in cassetta di ABS con bussole esagonali**  
▪ Cassetta in ABS ad alta resistenza con sistema di chiusura rapida.

DESCRIZIONE	ART./MISURA	PZ.
Chiavi a bussola con bocca esagonale	235 1/2 EN 8-9-10-11-12-13-14-15-16-17-18-19-21-22-23-24-27-30-32	19
Prolunghe	236 1/2 125-250	2
Snodo cardanico	241 1/2	1
Cricchetto reversibile certificato IP51	237 A 1/2	1



19 PEZZI

1 1/4"



1 kg | 210 mm | 130

606 1/4" EA  
U06060101

**Assortimento in cassetta di ABS con bussole esagonali**  
▪ Cassetta in ABS ad alta resistenza con sistema di chiusura rapida.

DESCRIZIONE	ART./MISURA	PZ.
Chiavi a bussola con bocca esagonale	235 1/4 EN 4-4,5-5-5,5-6-7-8-9-10-11-12-13-14	13
Prolunghe	236 1/4 50-100	2
Snodo cardanico	241 1/4	1
Lcva a T con attacco quadro scorrevole	240 1/4	1
Portabussola con impugnatura	243 1/4	1
Cricchetto reversibile certificato IP51	237 A 1/4	1

€134,00 **€ 80,00**



YouTube



38  
PEZZI

1/4"



900 g | 155 mm | 50 | 95

609 1/4" EB   
U06090002

**Assortimento con bussole esagonali ed inserti per avvitatura**

• Cassetta compatta in bimatereale con rivestimento soft-touch.

DESCRIZIONE	ART./MISURA	PZ.
Bussole esagonali	235 1/4" EN 5,5-6-7-8-9-10-11-12-13-14 mm	10
Prolunghe	236 1/4" 50-100	2
Cricchetto reversibile	237 B 1/4"	1
Snodo cardanico	241 1/4"	1
Impugnatura porta-bussola	243 1/4"	1
Inserti ad intaglio	660 0,6x4,5-1x5,5-1,2x6,5	3
Inserti PH	660 PH 1 2-3	3
Inserti PZ	660 PZ 1-2-3	3
Inserti esagonali	660 E 2-3-4-5-6	5
Inserti Torx® Tamper Resistant	660 STX T10-T15-T20-T25-T27-T30-T40	7
Inserto porta-bussola	660 Q 1/4"	1
Bussole porta-inserti	684 1/4"-1/4"	1

~~€ 212,00~~

**€ 148,00**

## CRICCHETTI CON IMPUGNATURA ROTANTE

1/4"

237 1/4" AK  
U02370003



**Cricchetto reversibile 1/4" con impugnatura rotante**

~~€ 53,50~~

**€ 37,40**

1/2"

237 1/2" AK  
U02370009



**Cricchetto reversibile 1/2" con impugnatura rotante**

~~€ 87,50~~

**€ 61,00**



17  
PEZZI

3/4"



612 3/4" EB   
U06120017

13 kg | 425 mm | 83 | 395

**Assortimento in cassetta di lamiera con bussole esagonali**

DESCRIZIONE	ART./MISURA	PZ.
Chiavi a bussola con bocca esagonale	235 3/4 N 22-23-24-26-27-28-30-32-36-38-41-46-50	13
Prolunghe	236 3/4 200-400	2
Leva a T scorrevole	240 3/4 N	1
Cricchetto reversibile con meccanismo sigillato 120 denti	237 B 3/4	1

~~€ 583,00~~

**€ 407,00**

612 3/4" B   
U06120016

**BUSSOLE  
POLIGONALI**

**Assortimento in cassetta di lamiera con bussole poligonali**

~~€ 586,00~~

**€ 407,00**



YouTube



## MINI KIT PER IL SERRAGGIO

Dimensioni compatte.  
Prestazioni al top!



31  
PEZZI

1/4

Inserto portabussole



350 g | 120 mm | 30 | 60



### 606 1/4" SK

U06060012

Assortimento inserti con cricchetto reversibile

DESCRIZIONE	ART./MISURA	PZ.
Cricchetto reversibile	237 1/4" SFK	1
Inserti ad intaglio	660 0,5x4-1x5,5	2
Inserti esagonali	660 E 1,5-2-2,5-3-4-5-6-7-8	9
Inserti a croce Phillips®	660 PH 1-2-3	3
Inserti a croce Pozidriv®-SUXPadriv®	660 PZ 1-2-3	3
Raccordo portainseriti	660 Q 1/4"	1
Inserti TORX® Tamper Resistant	660 STX T10-T15-T20-T25-T27-T30-T40	7
Inserti TORX®	660 TX 16-17-18-19	4
Prolunga magnetica	672 1/4" MG 100	1

~~€ 73,50~~

**€ 51,50**

### 610 1/4" EFK

U06100001

Assortimento bussole ribassate con cricchetto reversibile



YouTube



11  
PEZZI

1/4"

11 mm



265 g | 120 mm | 30 | 60

5,5-6-7-8-9-10-11-12-13-14 mm

#### BUSSOLE ESAGONALI RIBASSATE

Garantiscono il doppio dell'accessibilità rispetto all'utilizzo di un cricchetto standard.



**-50%**

### 237 1/4" SK

U02370062

Cricchetto reversibile con prolunga

- Testa snodata con movimento di 180°.
- Leva di inversione integrata.
- Funzione cricchetto: massima accessibilità grazie alla testa compatta ed allo snodo regolabile.
- Funzione chiave a T: la prolunga diventa un traversino e puoi usare il cricchetto come una chiave a T portainseriti.

~~€ 36,00~~

**€ 25,00**

Novità



1/4



## 454

**Estrattori a due bracci per esterni**

CODICE	A	B	POTENZA			
U04540000	65 mm	70 mm	1,5 t	13 mm	<del>€ 83,00</del>	<b>€ 58,00</b>
U04540010	90 mm	110 mm	3 t	17 mm	<del>€ 93,50</del>	<b>€ 65,50</b>
U04540020	130 mm	110 mm	3 t	17 mm	<del>€ 101,00</del>	<b>€ 70,50</b>
U04540030	175 mm	165 mm	4 t	17 mm	<del>€ 163,00</del>	<b>€ 114,00</b>
U04540040	220 mm	165 mm	4 t	17 mm	<del>€ 180,00</del>	<b>€ 126,00</b>
U04540050	270 mm	220 mm	5 t	21 mm	<del>€ 252,00</del>	<b>€ 176,00</b>
U04540060	340 mm	220 mm	5 t	21 mm	<del>€ 282,00</del>	<b>€ 197,00</b>

**KIT COMPLETO  
PER VITI E DADI  
DANNEGGIATI**

**20  
PEZZI**

→ 210  
↑ 60  
mm ↘ 130



## 458 S20

U04580312

**Assortimento di estrattori per viti e dadi esagonali danneggiati**

DESCRIZIONE	ART./MISURA	PZ.
Estrattori per viti e dadi esagonali danneggiati	458 B-8-10-11-12-13-14-15-16-17-18-19	11
Estrattori per viti esagonali danneggiati	458 C-2-2,5-3-4-5-6-7-8	8
Bussola portainseriti	684 1/4	1

~~€ 210,00~~

**€ 147,00**



**PROFILO ELICOIDALE PER DADI E VITI ESAGONALI**

Le bussole elicoidali coniche garantiscono una presa esterna efficace su esagoni danneggiati.

**COMPRESSE NEL PREZZO**



## 451 N/S4

U04510100

**Estrattore a tre bracci per esterni**

- Modello a bracci autoserranti.
- Capacità: 7÷140 mm.
- Potenza: 3 ton.
- Spina di sicurezza.
- Vite di manovra con esagono da 18 mm.
- Possibilità di utilizzo a due bracci.
- Viti di manovra M16x2.

~~€ 345,00~~

**€ 175,00**



Spina di sicurezza:  
utilizzo sicuro e qualità  
dell'attrezzo preservata



Autoserrante  
Autocentrante

**6  
PEZZI**

**Ø 1÷6 mm**



230 g | mm | → 140  
↑ 47  
↘ 133



## 458 S6

U04580012

**Serie di 6 estrattori conici**

- 458 1-2-3-4-5-6
- Per la rimozione di viti o prigionieri spezzati che non offrono possibilità di presa.
- Acciaio speciale altamente legato al cromo vanadio.
- Esecuzione satinata e brunita.
- Fornita in cassetta di materiale plastico.

~~€ 27,80~~

**€ 19,50**

## BARRE DINAMOMETRICHE 811 LB

L'EQUILIBRIO PERFETTO TRA PRECISIONE E RESISTENZA.

ISO 6789

**ATTACCO RAPIDO**

9X12 o 14X18 per accessori e teste a cricchetto.

**SCALA GRADUATA**

incisa sul tubo in acciaio.

**NONIO**

in acciaio.

**GHIERA DI REGOLAZIONE**

con ritorno automatico.

**IMPUGNATURA**

in bimateriale antiscivolo.

**MECCANISMO A SCATTO**

con molla di compressione.

Precisa  
**± 2%**

**PRECISIONE TESTATA  
IN FABBRICA.**

Resistente  
**50.000 scatti**

**TEST DI RESISTENZA  
DEL MECCANISMO.**

Come da Normativa ISO 6789, le barre dinamometriche USAG 811 LB sono testate una ad una in produzione, prima di essere confezionate.

Queste barre riescono a mantenere una soglia di precisione tra il ±2% ed il ±4% anche dopo 5.000 serraggi.



YouTube

PRECISIONE  
**±2%**

811 LB

**Barre dinamometriche a scatto**

ARTICOLO	CODICE	CAPACITÀ	Ø	L	RISOL.		
811 LB 50	U08115021	10÷50 Nm	9x12 mm	357 mm	1 Nm	<del>€ 285,00</del>	<b>€ 199,00</b>
811 LB 100	U08115023	20÷100 Nm	9x12 mm	437 mm	1 Nm	<del>€ 320,00</del>	<b>€ 229,00</b>
811 LB 200	U08115024	40÷200 Nm	14x18 mm	515 mm	1 Nm	<del>€ 342,00</del>	<b>€ 239,00</b>
811 LB 350	U08115025	70÷350 Nm	14x18 mm	725 mm	2 Nm	<del>€ 399,00</del>	<b>€ 279,00</b>

PRECISIONE  
**±2%**

811 LBE

**Chiavi dinamometriche a scatto con cricchetto reversibile amovibile**

ARTICOLO	CODICE	CAPACITÀ	Ø	Ø	L	RISOL.		
811 LBE 50	U08115026	10÷50 Nm	3/8"	9x12 mm	407 mm	1 Nm	<del>€ 365,00</del>	<b>€ 255,00</b>
811 LBE 100B	U08115027	20÷100 Nm	3/8"	9x12 mm	487 mm	1 Nm	<del>€ 408,00</del>	<b>€ 285,00</b>
811 LBE 100C	U08115028	20÷100 Nm	1/2"	9x12 mm	487 mm	1 Nm	<del>€ 410,00</del>	<b>€ 287,00</b>
811 LBE 200	U08115029	40÷200 Nm	1/2"	14x18 mm	565 mm	1 Nm	<del>€ 429,00</del>	<b>€ 300,00</b>
811 LBE 350	U08115032	70÷350 Nm	1/2"	14x18 mm	775 mm	2 Nm	<del>€ 486,00</del>	<b>€ 340,00</b>



**SERRAGGI  
DESTORSI  
E SINISTRORSI**

Cricchetto  
amovibile



**SERRAGGI  
DESTORSI  
E SINISTRORSI**

## CHIAVI DINAMOMETRICHE 810 SA - 811 SA CON LETTURA DIRETTA DELLA COPPIA DI SERRAGGIO.

**CRICCHETTO REVERSIBILE**  
con meccanismo a 72 denti.

**ISO 6789**



YouTube

**MECCANISMO A SCATTO**  
con molla di compressione.

**IMPUGNATURA CONICA**  
in bimatereale e antiscivolo.

**LETTURA DIRETTA**

Il valore della coppia impostato è subito visibile.

**REGOLAZIONE RAPIDA**

Imposti il valore di coppia necessario ancora più velocemente.



### 810 SA

**Chiave dinamometrica a lettura diretta con cricchetto reversibile**

- Include certificato di taratura e dichiarazione REACH (SVHC).

ARTICOLO	CODICE	CAPACITÀ	☑	L (mm)	RISOL.		
810 SA 50	U08105002	10÷50 Nm	3/8"	350	0,25	<del>€ 211,00</del>	<b>€ 147,00</b>
810 SA 100	U08105003	20÷100 Nm	1/2"	410	0,5	<del>€ 211,00</del>	<b>€ 147,00</b>
810 SA 200	U08105005	40÷200 Nm	1/2"	475	1,0	<del>€ 211,00</del>	<b>€ 147,00</b>
810 SA 340	U08105006	60÷340 Nm	1/2"	630	1,0	<del>€ 242,00</del>	<b>€ 170,00</b>

### 811 SE

**Chiave dinamometrica a lettura diretta con cricchetto amovibile**

- Include certificato di taratura e dichiarazione REACH (SVHC).

ARTICOLO	CODICE	CAPACITÀ	☑	⊖	L (mm)	RISOL.		
811 SE 50	U08115012	10÷50 Nm	3/8"	9x12	370	0,25	<del>€ 271,00</del>	<b>€ 190,00</b>
811 SE 100B	U08115013	20÷100 Nm	3/8"	9x12	430	0,5	<del>€ 271,00</del>	<b>€ 190,00</b>
811 SE 100C	U08115015	20÷100 Nm	1/2"	9x12	430	0,5	<del>€ 273,00</del>	<b>€ 191,00</b>
811 SE 200	U08115017	40÷200 Nm	1/2"	14x18	510	1,0	<del>€ 278,00</del>	<b>€ 194,00</b>
811 SE 340	U08115018	60÷340 Nm	1/2"	14x18	665	1,0	<del>€ 310,00</del>	<b>€ 216,00</b>

**SERRAGGI  
DESTROSI**

PRECISIONE  
**±4%**

**3/8"**

**1/2"**

Cricchetto  
amovibile

PRECISIONE  
**±4%**

**3/8"**

**1/2"**

**SERRAGGI  
DESTROSI  
E SINISTRORSI**



**SERRAGGI DESTROSI**

PRECISIONE  $\pm 4\%$

1/4"



**SERRAGGI DESTROSI E SINISTRORSI**

Cricchetto amovibile

PRECISIONE  $\pm 4\%$

1/4"



**SERRAGGI DESTROSI E SINISTRORSI**

PRECISIONE  $\pm 4\%$

3/4"

1/4"

PRECISIONE  $\pm 6\%$



## 810 N

ISO 6789

### Chiave dinamometrica con cricchetto reversibile

- Meccanismo a scatto con molla di compressione.
- Riarmo automatico: dopo lo scatto è subito pronta all'uso.
- Fornita con certificato di collaudo.

ARTICOLO	CODICE	CAPACITÀ	□	L	RISOL.		
810 N 5	U08104000	1÷5 Nm	1/4"	197 mm	0,05	<del>€ 231,00</del>	<b>€ 147,00</b>
810 N 25	U08104001	5 ÷ 25 Nm	1/4"	290 mm	0,05	<del>€ 231,00</del>	<b>€ 147,00</b>

## 811 NE

ISO 6789

### Chiave dinamometrica con cricchetto reversibile amovibile

- Cricchetto amovibile e sostituibile con gli inserti della gamma 811.
- Meccanismo a scatto con molla di compressione.
- Riarmo automatico: dopo lo scatto è subito pronta all'uso.
- Fornita con certificato di collaudo.

ART.	CODICE	CAPACITÀ	□	○	L	RISOL.		
811 NE 5	U08114009	1÷5 Nm	1/4"	9x12 mm	185 mm	0,05	<del>€ 269,00</del>	<b>€ 189,00</b>
811 NE 25	U08114010	5÷25 Nm	1/4"	9x12 mm	300 mm	0,05	<del>€ 274,00</del>	<b>€ 192,00</b>

## 812 N

ISO 6789

### Chiavi dinamometriche con cricchetto reversibile

- Modelli a coppia regolabile per serraggi destrorsi e sinistrorsi con rotazione del cricchetto di 180°.
- Precisione  $\pm 4\%$  del valore di coppia impostato.
- Scala di lettura in Nm.
- Meccanismo a scatto con molla di compressione.
- Riarmo automatico: dopo lo scatto è subito pronta all'uso.
- Blocco di sicurezza dopo la regolazione della coppia.
- Fornita in cassetta completa di certificato di collaudo.

ARTICOLO	CODICE	CAPACITÀ	□	○			
812 N 600	U08120006	120 ÷ 600 Nm	3/4"	14x18 mm		<del>€ 1.065,00</del>	<b>€ 746,00</b>
812 N 1000	U08120010	200 ÷ 1000 Nm	3/4"	-		<del>€ 1.932,00</del>	<b>€ 933,00</b>

## 824 A

ISO 6789

### Giraviti dinamometrici

- Modello a coppia regolabile per serraggi destrorsi da utilizzare in abbinamento agli inserti della serie 660 o, tramite raccordo, alle chiavi a bussola della serie mano da 1/4".
- Scala di lettura in Nm.
- Disinnesto automatico al raggiungimento della coppia impostata.
- Riarmo automatico dopo 120°.
- Fornito con chiave di regolazione e certificato di collaudo.

CODICE	CAPACITÀ	L	RISOL.		
U08240004	0,5÷2,5 Nm	145 mm	0,1	<del>€ 255,00</del>	<b>€ 179,00</b>
U08240006	2÷10 Nm	167 mm	0,5	<del>€ 261,00</del>	<b>€ 182,00</b>



## **FORBICE 207 E** CON STRUTTURA INTEGRALE IN ACCIAIO INOX.



YouTube



**L'UNICA CON STRUTTURA  
INTEGRALE IN ACCIAIO INOX**  
resiste alla flessione fino a 180 kg.

**SPELLAFILI  
INTEGRATO**



1. Spellatura.  
2. Crimpatura.

**TAGLIACAVI SU  
ENTRAMBE LE LAME**



Adatto per cavi  
multipolari.

**LAMA MICRODENTATA  
ANTISCIVOLO**



**207 E**  
U02070006

Forbice professionale per elettricisti

~~€ 42,40~~

**€ 29,50**

## **FORBICE 207 D**

**IL RIFERIMENTO PER GLI ELETTRICISTI.**



**IMPUGNATURA  
RESISTENTE ALLA  
FLESSIONE FINO A 80 kg**  
in tecnopolimero caricato vetro.

**ASOLE  
MAGGIORATE**

**207 D**  
U02070008

Forbice professionale  
per elettricisti

~~€ 26,50~~

**€ 18,60**



50 mm<sup>2</sup>



**LAME FLUIDE E ROBUSTE**  
In acciaio inox con  
microdentatura e tagliacavi.



YouTube



0,02÷10 mm<sup>2</sup>



**146 A**  
U01460003

### Pinza spellafili automatica dritta

- Funzioni di taglio e spellatura dei fili elettrici.
- Capacità 0,02-10 mm<sup>2</sup>/AWG 34-80.
- Ganasce intercambiabili senza uso di utensili.
- Tagliafili integrato nel corpo dell'utensile.
- Regolazione precisa del diametro di spellatura per evitare il danneggiamento dei conduttori.
- Lunghezza di spellatura regolabile.
- Dopo ogni singola spellatura, la ganasce si apre automaticamente per facilitare l'estrazione del filo.
- Impugnature ergonomiche bimatériauale.

~~€ 104,00~~

**€ 73,00**



0,5÷1-1,5-2,5-4-6 mm<sup>2</sup>

**753 A**  
U07530003

### Pinza per terminali a puntale

- Modello a cremagliera per ridurre lo sforzo di compressione
- Impugnature ergonomiche in PVC che facilitano il serraggio con una mano sola.
- Matrice in acciaio inox a 5 impronte.
- Corpo in lamiera d'acciaio.

~~€ 103,00~~

**€ 72,00**



15÷25  
WATT

MAX  
495°C

**063 W**  
U00630002

### Saldatore a stilo per elettronici a doppia potenza

- Saldatore professionale per stagno.
- Commutatore di potenza a pulsante.
- Ideale per diversi tipi di applicazioni in campo elettrotecnico.
- Punta in acciaio ad alta durata.
- Corpo in materiale plastico resistente ad olii ed idrocarburi.
- Alimentazione 230V.
- Fornito con supporto da banco.

~~€ 67,00~~

**€ 47,00**



2011/65/UE  
2012/19/EC

**Isolati**



**Non isolati**



0,14÷10 mm<sup>2</sup>

**753 KA**  
U07530004

### Crimpatrice autoregolante per puntalini a sezione quadra

- Per puntalini isolati e non isolati.
- Capacità 0,14-10 mm<sup>2</sup>/AWG 26-8.
- Sistema di ripresa per operazioni multiple consecutive.
- Permette di crimpare applicando poca forza sulle impugnature.
- Peso ridotto e dimensioni compatte per maggiore maneggevolezza.

~~€ 243,00~~

**€ 170,00**

## SMART FUNCTION

Selezione automatica della  
tensione AC/DC, resistenza  
e frequenza

MAX  
600 V

RMS



**074 A**  
U00740001

### Multimetro digitale compatto SMART

- Misurazione di AC/DC.
- Misurazioni di resistenza e continuità (suono acustico se resistenza circuito è inferiore 40  $\Omega$ ).
- Misurazioni frequenza.
- Misurazione corrente AC/DC con pinza amperometrica 076 P.



CAT III 600V

#### CARATTERISTICHE TECNICHE

Tensione continua DC	1÷600 mV÷V
Tensione alternata AC	1÷600 mV÷V
Resistenza	0÷10 $\Omega$ ÷M $\Omega$
Frequenza	3÷40 kHz
Tipo batterie (fornite)	2xAAA 1,5V

~~€ 150,00~~

**€ 105,00**



$\emptyset$  4÷28 mm<sup>2</sup>



YouTube

**163**  
U01630001

### Sguainacavi multifunzione

- Per il taglio circolare e longitudinale di cavi con rivestimento esterno in PVC.
- Sistema a grilletto (-30% di sforzo): forza necessaria 75 N.
- Rotella di avanzamento della lama.
- Lama di spellatura auto rotante.
- Blocco grilletto con lama estratta.
- Blocco di sicurezza della lama.
- Corpo ergonomico in materiale plastico.
- Lama di ricambio inclusa.
- Kit lame di ricambio codice 872272.

~~€ 41,80~~

**€ 29,30**



**007 MV**  
U00070035

### Marsupio portautensili (vuoto)

- Tessuto ad altissima resistenza.
- Sistema di fissaggio alla cintura con chiusura in velcro.
- 4 tasche portautensili elasticizzate.
- Gancio porta nastro.

~~€ 21,50~~

**€ 15,00**



**007 MLV**  
U00070030

### Marsupio portautensili con cintura (vuoto)

- Tessuto ad altissima resistenza.
- 6 tasche portautensili elasticizzate.
- Gancio porta nastro.
- Cintura regolabile da 80 a 120 cm.

~~€ 42,90~~

**€ 30,00**



## 305 N

### Giratubi modello svedese con ganasce a 90° diritte

- Acciaio al cromo vanadio.

CODICE	CAPACITÀ	LUNGHEZZA		
U03050002	1"	40 mm	330 mm	<del>€ 40,10</del> <b>€ 28,00</b>
U03050003	1 1/2"	55 mm	420 mm	<del>€ 53,50</del> <b>€ 37,50</b>
U03050004	2"	67 mm	540 mm	<del>€ 82,00</del> <b>€ 57,00</b>
U03050005	3"	103 mm	690 mm	<del>€ 123,00</del> <b>€ 86,00</b>



**RAME**

**314 DA**  
U03140033

Ø  
**3-35**  
mm

Ø  
**1/8-1 3/8**  
"

### Tagliatubi per tubi in rame e lega leggera

- Modello ad avanzamento telescopico e ingombro costante.
- 4 rulli di scorrimento scanalati per il taglio di tubi bordati.
- Sostituzione rapida della rotella senza bisogno di utensili.
- Pomello ergonomico.

~~€ 74,00~~

**€ 52,00**



**PLASTICA**



**317 K**  
U03170012

Ø  
**35**  
mm

Ø  
**1 3/8**  
"

### Tagliatubi per tubi in plastica

- Per il taglio di tubi in PEX, PEHD, PVC, PER.
- Modello a cremagliera per un'azione di taglio progressiva con il minimo sforzo.
- Corpo in lega leggera.
- Esecuzione verniciata.

~~€ 58,00~~

**€ 40,50**



**RAME**

**314 C**  
U03140032

Ø  
**3-30**  
mm

Ø  
**1/8-1 1/8**  
"

### Tagliatubi per tubi in rame e lega leggera

- Rulli di scorrimento scanalati per il taglio di tubi bordati.
- Sostituzione rapida della rotella senza bisogno di utensili.
- Spessore massimo tubo: 2 mm.

~~€ 37,40~~

**€ 26,00**



**PLASTICA**



**317 AM**  
U03170001

Ø  
**22**  
mm

Ø  
**7/8**  
"

### Tagliatubi per tubi in PEX e plastica

- Lama con geometria speciale e rivestimento in PTFE.
- Ritorno automatico della lama.
- Sistema di chiusura con una sola mano.
- Dimensioni: 169x50x19 mm.

~~€ 43,70~~

**€ 30,00**

ALLUMINIO

360°



**995 AF**  
U09950006

**Rivettatrice con testa orientabile**

- Capacità: Ø 2,4 - 3,2 - 4 - 4,8 mm (3/32 - 1/8 - 5/32 - 3,16").
- Testa orientabile liberamente a 360°.
- Adatta a rivetti in alluminio.
- 4 testine intercambiabili.
- Corpo in lega leggera.
- Clip in metallo per blocco apertura.
- Chiave smontaggio testine in dotazione.

~~€ 35,40~~

**€ 24,80**

285 mm



ALLUMINIO  
E ACCIAIO

**995 A**  
U09950001

**Rivettatrice**

- Capacità acciaio: Ø 2,4 - 3,2 - 4 (3/32 - 1/8 - 5/32).
- Capacità alluminio: Ø 2,4 - 3,2 - 4 - 4,8 mm (3/32 - 1/8 - 5/32 - 3,16").
- Corpo in lega leggera.
- Leva di pressione in lamiera d'acciaio imbutita.
- Molla di richiamo per l'apertura dei manici.
- Fornita con 3 testine intercambiabili e chiave di servizio.

~~€ 33,00~~

**€ 23,10**



**-20%  
DI SFORZO**

**COMPATTA E POTENTE**

Solo 330 mm di lunghezza 20% di sforzo in meno rispetto al modello standard.



ALLUMINIO  
E ACCIAIO

**995 LA**  
U09950004

**Rivettatrice dritta compatta**

- Capacità: Ø 2,4 - 3,2 - 4 - 4,8 - 6,4 mm (3/32 - 1/8 - 5/32 - 3,16 - 1/4").
- Modello compatto con la stessa capacità di una rivettatrice lunga standard.
- Il sistema di leve interno riduce lo sforzo dell'operatore.
- Adatta a rivetti in alluminio ed acciaio.
- 5 testine intercambiabili.
- Serbatoio amovibile per recupero steli.
- Corpo in lega leggera.

~~€ 62,50~~

**€ 43,80**

Ø  
M4 - M5  
M6 - M8



**FORNITA  
IN CASSETTA**

**PER RIVETTI  
FILETTATI**  
(non inclusi)

**995 CA**  
U09950008

**Rivettatrice per inserti filettati**

- Modello compatto con sistema di leve interno che garantisce meno sforzo all'operatore durante l'utilizzo.
- Fornita con 4 tiranti intercambiabili (M4-M5-M6-M8).
- Utilizzabile con rivetti in alluminio e acciaio (M4-M5-M6-M8) e acciaio inox (M4-M5).
- Corpo in lega leggera.
- Manici in materiale plastico.
- Fornita in valigetta di plastica (LxPxH: 320x175x50 mm) con vari portainseriti filettati (non inclusi).

~~€ 90,00~~

**€ 63,00**

**LAME IN ACCIAIO INOX**



**211 A**  
U02110001

**Forbice multiuso**

- Lama con microdentatura antiscivolo.
- Leva per la selezione di mani piccole/grandi.
- Leva di sicurezza per il bloccaggio delle lame.
- Impugnature ergonomiche bimalteriali antiscivolo.

~~€ 23,40~~

**€ 16,40**



**LAME IN ACCIAIO INOX**



**210 C**  
U02100003

**Forbice multiuso**

- Lama microdentata antiscivolo in acciaio inox.
- Grandi impugnature ergonomiche in bimalteriale.
- Perfetta per il taglio di alluminio, cartone, gomma, cuoio, moquette, ecc.

~~€ 20,60~~

**€ 14,40**

**ADATTA PER DESTRIMANI**



**200 S**  
U02000002

**Seghetto**

- Anima in acciaio rivestita in materiale plastico antiscivolo ed antiurto.
- Fornito con lama al cobalto mod. 200 C24.

~~€ 35,90~~

**€ 25,10**

**TAGLIENTE CENTRALE**



**196 N**

**Troncabulloni a tagliente centrale**

CODICE	LUNGHEZZA	TAGLIO 2000 N/mm <sup>2</sup> Ø MAX	TAGLIO 1600 N/mm <sup>2</sup> Ø MAX	PESO	<del>€</del>	<b>€</b>
U01960002	450 mm	6 mm	7 mm	1,9 Kg	<del>80,50</del>	<b>56,00</b>
U01960003	600 mm	7 mm	10 mm	3,5 Kg	<del>101,00</del>	<b>70,50</b>
U01960004	750 mm	9 mm	13 mm	4,5 Kg	<del>130,00</del>	<b>91,00</b>
U01960005	900 mm	10 mm	16 mm	6,1 Kg	<del>170,00</del>	<b>124,00</b>
U01960006	1050 mm	11 mm	18 mm	8,3 Kg	<del>262,00</del>	<b>183,00</b>



**442 TA**  
U04420013

**Asta telescopica con terminale magnetico snodato**

- Per il recupero di pezzi magnetizzabili da luoghi difficilmente accessibili.
- Materiale testa snodata: alluminio.

~~€ 14,00~~

**€ 9,90**

**CAPACITÀ MAX 2 kg**



**TAGLIENTE SEMI RASO**



**196 NR**  
U01960001

**Troncabulloni a tagliente semi raso**

- Lama con taglienti ad alta resistenza.
- Impugnature in PVC.

~~€ 69,00~~

**€ 48,00**

2-3-4-5-6-8 mm

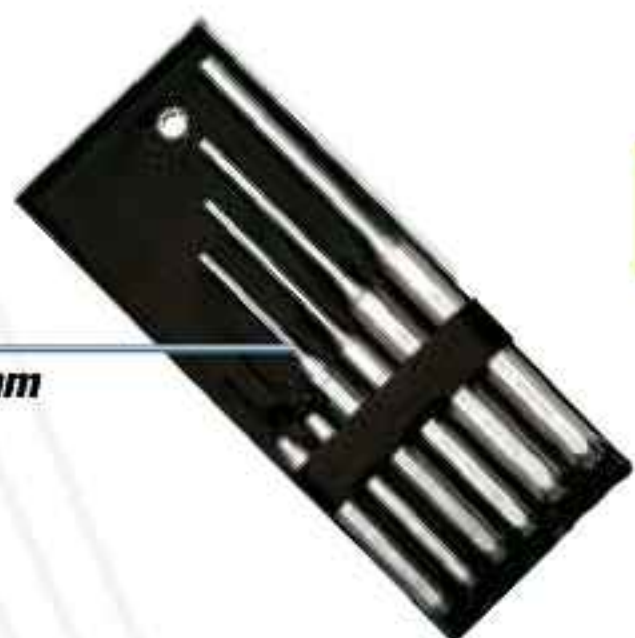

6  
PEZZI

## 367 SE6

U03670081

### Serie di 6 cacciaspine

- 367/2x100-3x130-4x145-5x165-6x180-8x200 mm.
- Fornita in busta di plastica.
- Acciaio al cromo vanadio.
- Punta riportate e fosfatate per le misure da 2 e 3 mm.

~~€ 56,50~~

**€ 39,60**

## UNI 7784

### 376

#### Mazzuole

- Modello a tasselli intercambiabili in materiale plastico.
- Corpo in acciaio al carbonio.
- Manico in frassino.

CODICE	Ø TASSELLI	LUNGHEZZA	<del>€</del>	€
U03760001	22 mm	250 mm	<del>€ 14,10</del>	<b>€ 9,85</b>
U03760002	28 mm	275 mm	<del>€ 17,10</del>	<b>€ 12,00</b>
U03760003	35 mm	300 mm	<del>€ 21,60</del>	<b>€ 15,20</b>
U03760004	42 mm	325 mm	<del>€ 29,10</del>	<b>€ 20,50</b>
U03760005	50 mm	350 mm	<del>€ 40,00</del>	<b>€ 28,00</b>
U03760006	60 mm	380 mm	<del>€ 58,00</del>	<b>€ 40,40</b>



### MATERIALI COMBINATI PER UN RISULTATO OTTIMALE.

- 1 Anima in grafite: massima resistenza alla flessione.
- 2 Elevata qualità: corpo in polipropilene che assorbe le vibrazioni.
- 3 Rivestimento in gomma resistente agli idrocarburi.



DIN 1041

### 382 F

#### Martelli per meccanici manico in graphite

- Modello tedesco a testa quadra piana e penna simmetrica.
- Manico in graphite.

CODICE	PESO TESTA	LUNGHEZZA	<del>€</del>	€
U03820102	200 g	285 mm	<del>€ 19,30</del>	<b>€ 13,50</b>
U03820103	300 g	300 mm	<del>€ 20,80</del>	<b>€ 14,60</b>
U03820105	500 g	310 mm	<del>€ 23,50</del>	<b>€ 16,40</b>
U03820107	800 g	350 mm	<del>€ 29,00</del>	<b>€ 20,30</b>
U03820108	1000 g	355 mm	<del>€ 31,50</del>	<b>€ 22,00</b>

Testa in acciaio al carbonio forgiata e sottoposta a trattamento termico differenziato per garantire una maggiore durata ed evitare scheggiature o ricalcature della superficie battente.

## UNI 7777 DIN 6475

CODICE	PESO TESTA	LUNGHEZZA	<del>€</del>	€
U03820002	100 g	260 mm	<del>€ 11,10</del>	<b>€ 8,15</b>
U03820004	200 g	280 mm	<del>€ 12,20</del>	<b>€ 8,55</b>
U03820006	300 g	300 mm	<del>€ 13,50</del>	<b>€ 9,45</b>
U03820007	400 g	310 mm	<del>€ 16,00</del>	<b>€ 11,20</b>
U03820008	500 g	320 mm	<del>€ 18,00</del>	<b>€ 12,60</b>
U03820009	600 g	330 mm	<del>€ 20,80</del>	<b>€ 14,50</b>
U03820010	800 g	350 mm	<del>€ 24,10</del>	<b>€ 16,90</b>
U03820011	1000 g	360 mm	<del>€ 27,10</del>	<b>€ 19,00</b>
U03820013	1500 g	380 mm	<del>€ 36,30</del>	<b>€ 25,30</b>
U03820014	2000 g	400 mm	<del>€ 47,00</del>	<b>€ 32,90</b>

### 382

#### Martelli per meccanici

- Modello tedesco a testa quadra piana e penna simmetrica.
- Manico in frassino.





## 997 A

### Strettoio a vite

- Corpo e asta scorrevole in acciaio forgiato.

CODICE	APERTURA	SEZIONE	PESO	<del>€</del>	€
U09970002	160 mm	16x7,5 mm	0,5 kg	€28,20	€ 19,70
U09970003	200 mm	19,5x9,5 mm	0,9 kg	€35,10	€ 24,60
U09970004	250 mm	22x10,5 mm	1,2 kg	€42,10	€ 29,50
U09970005	300 mm	25x12 mm	1,8 kg	€53,50	€ 37,40
U09970006	400 mm	25x12 mm	1,9 kg	€56,00	€ 39,20
U09970007	500 mm	25x12 mm	2,1 kg	€61,00	€ 42,70
U09970008	600 mm	25x12 mm	2,3 kg	€66,00	€ 46,20
U09970009	800 mm	27x13 mm	3,3 kg	€86,50	€ 60,50
U09970010	1000 mm	27x13 mm	3,7 kg	€98,00	€ 68,50

## 997 B

### Strettoio rapido a leva

- Regolazione e sgancio rapidi tramite leva e pulsante integrato.
- Corpo e asta scorrevole in acciaio forgiato.

CODICE	APERTURA	SEZIONE	PESO	<del>€</del>	€
U09970013	120 mm	13,5x6,5 mm	0,7 kg	€59,50	€ 37,40
U09970014	160 mm	16x7,5 mm	1 kg	€59,00	€ 41,30
U09970015	200 mm	19,5x9,5 mm	1,3 kg	€71,50	€ 50,00
U09970016	250 mm	22x10,5 mm	1,9 kg	€83,00	€ 58,00
U09970017	300 mm	25x12 mm	2,7 kg	€102,00	€ 71,50
U09970018	400 mm	25x12 mm	2,8 kg	€107,00	€ 75,00
U09970019	500 mm	25x12 mm	3 kg	€112,00	€ 78,50

PIANO  
REGOLABILE

LEVA CON PULSANTE  
DI SGANCIO INTEGRATO



10  
PEZZI

## 282 S10

U02820200

2 kg | 330 mm | 180 | 215

### Assortimento in cassetta di ABS con chiavi a compasso per ghiera a nasello tondo e quadro

- Chiavi a compasso per ghiera con fori e con intagli.
- Le chiavi si regolano agendo sulla vite centrale.
- Naselli amovibili.
- Diametri ghiera: da 20 a 100mm.
- Finitura cromata satinata.
- Cassetta in ABS ad alta resistenza con sistema di chiusura a clip.

### PER GHIERE CON DIAMETRI DA 20 A 100 mm

Ghiere con fori  
sulla parte superiore

Ghiere con intagli  
sulla parte superiore



DESCRIZIONE	MISURA	PZ.
Naselli tondi	(d) 2,5 - 3 - 4 - 5 - 6 - 7 - 8 - 9 mm	4
Naselli quadri	(a) 4 - 5 - 6 - 8 mm	4

~~€161,00~~

**€ 112,00**



## DIN 338

HSS-G

14  
PEZZI



### 988 LA/S14

U09880070

#### Assortimento di punte e maschi

- Ø punte: 2,5-3,3-4,2-5,0-6,8-8,5-10,2 mm.
- M maschi: 3x0,5-4x0,7-5x0,8-6x1-8x1,25-10x1,5-12x1,75 mm.

~~€ 88,00~~

**€ 61,50**

## DIN 338

HSS-G

19  
PEZZI



### 988 MA/S19

U09880073

#### Assortimento di punte

- Ø punte: 1,0-1,5-2,0-2,5-3,0-3,5-4,0-4,5-5,0-5,5-6,0-6,5-7,0-7,5-8,0-8,5-9,0-9,5-10,0 mm.

~~€ 53,50~~

**€ 37,40**

## DIN 338

HSS-G

25  
PEZZI



### 988 MA/S25

U09880074

#### Assortimento di punte

- Ø punte: 1,0-1,5-2,0-2,5-3,0-3,5-4,0-4,5-5,0-5,5-6,0-6,5-7,0-7,5-8,0-8,5-9,0-9,5-10,0-10,5-11,0-11,5-12,0-12,5-13,0 mm.

~~€ 106,00~~

**€ 74,00**



HSS

3  
PEZZI



### 988 D/S3

U09880020

#### Serie di 3 frese a scalino

ART.	Ø SCALINI	Ø CODOLO	LUNG.
988 D1	4-5-6-7-8-9-10-11-12 mm	6 mm	65 mm
988 D2	4-6-8-10-12-14-16-18-20 mm	8 mm	75 mm
988 D3	4-6-8-10-12-14-16-18-20-22-24-26-28-30 mm	10 mm	100 mm

~~€ 196,00~~

**€ 138,00**

HSS

12  
PEZZI



### 988 G/S12

U09880100

#### Serie di 10 seghe a tazza bimetalliche

- Ø 19-22-25-29-35-38-44-51-57-64 mm.
- Profondità di taglio max: 38 mm.

~~€ 202,00~~

**€ 141,00**

HSS

10  
PEZZI



### 988 E/S10

U09880062

#### Frese rotative in metallo duro

- N°8 pezzi (Ø 10 e 12 forme EA-EC-EF-EG).
- N°2 pezzi (Ø 12 forme ED-EM).

~~€ 496,00~~

**€ 230,00**





YouTube



Ganci orientabili



SMD  
LED



COB  
LED



1 = 18 h  
2 = 3,6 h  
3 = 1,8 h



Li-ion

**RICARICABILE**



USB-C

**889 RL**  
U08890036

Lampada di ispezione a LED

~~€ 84,00~~

**€ 59,00**

**DOPPIA FUNZIONE**



**45  
LUMEN**

**LAMPADA**



**MAX  
420  
LUMEN**

**TORCIA**

2 livelli di luminosità  
(120 e 420 lumen)



YouTube



Base magnetica con  
morsetto e gancio



SMD  
LED



COB  
LED



1 = 3 h  
2 = 10 h  
3 = 35 h



Li-ion

**RICARICABILE**



USB-C

**889 IL**  
U08890046

Lampada di ispezione articolata a LED

~~€ 84,00~~

**€ 59,00**

**TRIPLA FUNZIONE**



**50  
LUMEN**

**TESTA**



**400  
LUMEN**

**TORCIA**



**150  
LUMEN**

**FRONTALE**



YouTube



**SENSORE DI  
MOVIMENTO**



SMD  
LED



IP54



1 = 18 h  
2 = 3,6 h  
3 = 1,8 h



Li-ion

**RICARICABILE**



USB-C

**889 GR**  
U08890044

Faretto compatto a LED

~~€ 113,00~~

**€ 79,00**

**3 LIVELLI DI LUMINOSITÀ**



**MAX  
500  
LUMEN**

50, 250 e 500 lumen con un semplice tocco.

**Solo 91 mm  
di lunghezza**

**Novità**

**Solo 94 mm di lunghezza**



COB LED



IP20

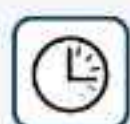

1 = 1,5 h  
2 = 3 h  
3 = 3h



Li-ion

**RICARICABILE**



**USB-C**



Lampada COB LED



Torcia SMD LED



IP20



Li-ion



**USB-A**



COB LED



IP67



2,5 h



1 = 8 h  
2 = 4 h  
3 = 2,5 h



IK07

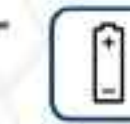

Li-ion

**889 SP**  
U08890055

**Torcia tascabile a LED**

~~€ 42,70~~

**€ 29,90**



YouTube

**DOPPIA FUNZIONE**



Frontale

**150 LUMEN**



Torcia

**150 LUMEN**

Clip di aggancio magnetico, orientabile a 360°

Corpo in alluminio

**360°**

**180°**



**889 RP**  
U08890045

**Lampada a LED ricaricabile compatta**

~~€ 68,50~~

**€ 48,00**



YouTube

**DOPPIA FUNZIONE**



Lampada

**180 LUMEN**



Torcia

**60 LUMEN**

160 mm

130 mm



**889 RT**  
U08890038

**Faretto a LED**

~~€ 295,00~~

**€ 207,00**



YouTube

**3 LIVELLI DI LUMINOSITÀ**

**MAX 1500 LUMEN**



500, 1000 e 1500 lumen con un semplice tocco.

**FUNZIONA CON O SENZA CAVO!**  
Cavo da 5 metri incluso.

## TRASFORMATORE INTEGRATO

Nessun alimentatore esterno.



YouTube

12 V 1200 A

10 kg 400 mm 320 mm 115



1613 RA12  
U16130019

3500 A

### Avviatore portatile 12V

- Scocca antiurto in ABS.
- Idoneo anche per batterie sigillate.

Lunghezza cavi  
155 cm

~~€ 583,00~~

€ 408,00

## CONNETTORE POSTERIORE PER SELEZIONE VOLTAGGIO



12 V 1400 A  
24 V 700 A

20,8 kg 560 mm 200 mm 590



12V - 3700 A

1613 AGM12-24  
U16130013

24V - 1860 A

### Avviatore professionale portatile 12V-24V

- Scocca antiurto in ABS.
- Protezione da sovratensione.

Lunghezza cavi  
155 cm

~~€ 1.322,00~~

€ 925,00



YouTube

## POTENZA DI COMPRESSIONE

735 kg (6 bar), 1226 kg (10 bar).

447 T  
U04470101

### Smonta ammortizzatori pneumatico

- Ideale per autovetture.
- Fornito con due staffe inferiori 447 TC1 (78÷130 mm) e 447 TC2 (105÷182 mm), morsa 447 TA e morsetti superiori universali 447 TB1.

#### CARATTERISTICHE TECNICHE

Potenza compressione	735 kg (6 bar) - 1226 kg (10 bar)
Pressione di esercizio	6-10 bar
Correa del pistone	420 mm
Cilindro	Doppio in lega d'alluminio e resina al nylon

60 kg 470 mm 1.390 mm 450

~~€ 1.974,00~~

€ 1.381,00

## Pressione regolabile FINO A 4 BAR

12 V 10 litri

2847/3  
U28470084

### Spurgatore per circuito freni

- Permette di cambiare, riempire, spurgare i circuiti dei freni di autovetture e veicoli industriali.
- Apparecchio progettato esclusivamente per liquidi freno tipo DOT 3, DOT 4, DOT 5.1. No LHM.

#### CARATTERISTICHE TECNICHE

Sistema di manovra del liquido	Pompa peristaltica (nessun contatto diretto pompa liquido, nessuna pressione aria sul liquido)
Alimentazione	12 V (morsetti batteria)
Capacità serbatoio	10 litri
Limitatore di pressione	4 bar
Tubo a spirale	4 m (elastico)
Cavo di alimentazione	4 m



#### Fornito con:

- guarnizioni di ricambio,
- 1 tappo multidiametro 44-45-46 mm (2847 N11).
- 1 contenitore di recupero olio.

~~€ 1.558,00~~

€ 1.091,00

**PER BATTERIE**  
**6÷12 V**

*Anche per sistema  
Start & Stop*



**890 K**

**U08901000**

Tester digitale per batterie con stampante

~~€ 697,00~~

**€ 489,00**



**IDEALE PER IMMETTERE  
OLIO NEL DIFFERENZIALE**

*Non adatta per carburanti  
e olii minerali*

**1,5**  
Litri



**421 P**

**U04210020**

Siringa per olio

~~€ 70,00~~

**€ 49,00**

**3**  
Litri

**IDEALE PER SPURGO  
DEL LIQUIDO DEI  
FRENI O FRIZIONE**

Pressione  
di utilizzo  
6÷10 bar



**2847 A**

**U28470086**

Spurgatore a depressione

~~€ 100,00~~

**€ 70,00**



YouTube



Compatibile  
con termocoppia K.



**1651**

**U16510001**

Termometro digitale ad infrarossi

~~€ 189,00~~

**€ 132,00**

**IDEALE PER ASPIRAZIONE ED  
EROGAZIONE DI OLIO, LIQUIDO  
ANTIGELO E OLIO SERVOSTERZO**



**421 M**

**U04210021**

Siringa in metallo

~~€ 28,00~~

**€ 19,60**

**9,5**  
Litri



4,1 kg | mm | 230  
627  
302



**1785 B**

**U17850005**

Aspiratore liquidi  
manuale e pneumatico

~~€ 231,00~~

**€ 162,00**



30,5 kg | mm | 615 | 344

3 TON 30,5 kg

CE

3t



**2550 A**  
U25500001

**Sollevatore idraulico 3T per auto e veicoli commerciali**

- Struttura in acciaio.
- Portata elevata per utilizzo su auto, fuoristrada e furgoni.
- Sistema a doppia pompa per sollevare più velocemente la vettura.
- Dotato di comando di discesa manuale.
- Valvola di spurgo dell'aria, per evitare il pericolo di over-carico.

~~€ 347,00~~

**€ 234,00**



32,5 kg | mm | 762 | 350

2 TON 32,5 kg

CE

2t



**2550 B**  
U25500002

**Sollevatore idraulico 2T**

- Struttura in acciaio.
- Per utilizzo in spazi ridotti.
- Sistema a doppia pompa per sollevare più velocemente la vettura.
- Dotato di pedale di avvicinamento.
- Dotato di comando di discesa manuale.
- Valvola di spurgo dell'aria, per evitare il pericolo di over-carico.

~~€ 490,00~~

**€ 343,00**

2 PEZZI

**1950 C**

**Coppia colonnette**

- Altezza regolabile tramite meccanismo dentato con rilascio a leva.
- Perno di bloccaggio con catena.
- 1950 C/3: modello regolabile a 10 posizioni.
- 1950 C/6: modello regolabile a 13 posizioni.



4,6 kg | mm | 1.030 | 480 | 115

**2000 A**  
U20000100

**Lettino sottoscocca 6 ruote**

- Cuscino poggiatesta in vinile resistente agli idrocarburi.
- Struttura in materiale plastico resistente agli idrocarburi, lavabile.

~~€ 124,00~~

**€ 87,00**



**CODICE PORT. H MAX H MIN DIMENSIONI PESO**

U19501001 3t 427 mm 300 mm 207x188 mm 7 kg ~~€ 96,50~~ **€ 67,50**

U19501002 6t 620 mm 400 mm 285x250 mm 14 kg ~~€ 139,00~~ **€ 97,50**



3  
PEZZI

1 1/2"

**270 C/C3**  
U02700106

Assortimento in cassetta modulare con bussole macchina per cerchi in lega con protezione in téflon

~~€ 60,00~~

**€ 42,00**

→ 190  
↓ 58  
mm ↗ 144

**È POSSIBILE RIPORLO  
NEI CASSETTI DEI  
NOSTRI CARRELLI**

Maniglia per il trasporto

230 g | 475 mm | 50 mm | 290 mm

**2000 G**  
U20000110

Tappeto per protezione ginocchia

~~€ 29,00~~

**€ 20,30**



YouTube  
**VIDEO  
TUTORIAL**



10  
PEZZI

**KIT UNIVERSALE PER LA RIMOZIONE  
DI DADI E VITI ANTIFURTO**

**272 DS**  
U02720001

Kit estrazione dadi e viti antifurto

- Non danneggia il cerchio in lega.
- Punta speciali al carburo di tungsteno in grado di forare qualsiasi tipo di materiale (lubrificare con olio da taglio ad ogni utilizzo).
- Bussole coniche per centraggio/estrazione super sottili per accedere su ogni tipo di cerchio in lega.

~~€ 292,00~~

**€ 204,00**



**Utilizzo manuale sui dadi ruota danneggiati**

3  
PEZZI

1 1/2"

**XGRIP**

**235 1/2" XL/C3**  
U02354100

Assortimento in cassetta modulare con bussole lunghe con bocca esagonale speciale X-Grip

~~€ 30,00~~

**€ 21,00**



**Novità**

**I VANTAGGI DEL PROFILO X-GRIP:**

- Presa perfetta su esagoni nuovi e danneggiati fino all'80%.
- Trasmette una coppia superiore rispetto a una bussola standard.
- Non danneggia gli esagoni nuovi.

**XGRIP**



**Scopri tutte le  
caratteristiche e  
la gamma a pag. 4**

## CHIAVE FILTRI OLIO 443 N CON REGOLAZIONE AUTOMATICA DEL NASTRO.



**SERRAGGIO AUTOMATICO  
DEL NASTRO**

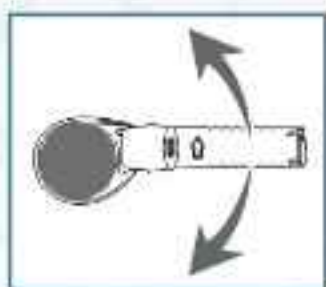

**EFFETTO CRICCHETTO**

Rapidità d'uso anche in spazi ridotti.



**LEVA DI INCREMENTO  
POTENZA SERRAGGIO**



**443 N**  
U04430005

Chiave automatica a  
ripresa rapida per filtri  
olio (autovetture)



66÷105  
mm

~~€ 105,00~~

**€ 73,50**



YouTube

**446 DA/SE6**  
U04461104

**Serie di 6 chiavi per coperchio filtro olio**

- 1 chiave 14 tacche Ø 76 mm.
- 1 chiave 14 tacche Ø 102 mm.
- 1 chiave 16 tacche Ø 76 mm.
- 1 chiave 16 tacche Ø 88 mm.
- 1 chiave 18 tacche Ø 66 mm.
- 1 chiave 18 tacche Ø 96 mm.
- Quadro di manovra 3/8".

~~€ 215,00~~

**€ 151,00**



Permettono il riserraggio alla coppia  
originale di smontaggio (valore indicato  
sulla campana di plastica)



Inquadra il QR code per scaricare la tabella  
delle applicazioni o vai su usag.it

**3/8"**

**1/2"**

**30  
PEZZI**

7 kg | 620 mm | 500

**446 S28**  
U04461204

**Assortimento di 30 chiavi per filtri olio**

- Misure delle 28 chiavi a tazza Ø x N°lati:  
66/6 - 65/14 - 65/67 - 68/14 - 73/14 - 74/15 -  
74/76 - 75/77 - 76/12 - 76/14 - 76/30 - 76/8  
- 78/15 - 80/15 - 80/82 - 86/16 - 86/18 -  
90/15 - 92/10 - 93/15 - 93/36 - 93/45 - 95/15  
- 96/18 - 100/15 - 106/15 - 108/15 - 108/18.

~~€ 204,00~~

**€ 143,00**





Inquadra il QR code per scaricare la tabella delle applicazioni o vai su usag.it



**IN ALLUMINIO**

**446 DT/S2**

U04461203

**Serie di 2 chiavi per coperchi filtro olio modelli giapponesi**

- Riduce i rischi di danneggiamento dei coperchi filtri.
- Utilizzabili anche in serraggio con chiave dinamometrica.



2  
PEZZI

~~€ 60,50~~

**€ 42,30**



**2 in 1**



**871 D**

U08710001



**Pinza per anelli stringitubo a presa frontale/laterale**

- Possibilità di aggancio frontale o laterale.
- Ganasce con superficie di presa zigrinata.

~~€ 54,50~~

**€ 38,20**

3 posizioni di lavoro



**871 C**

U08719005P

**Pinza per fascette automatiche CLIC**

- Testa triassiale per lavorare in tutte le posizioni.
- Permette di aprire o chiudere le fascette automatiche presenti sui circuiti del carburante, dei collettori d'aspirazione e dei circuiti idraulici.

~~€ 77,50~~

**€ 54,00**

Inquadra il QR code per scaricare la tabella delle applicazioni o vai su usag.it



**263/S16**

U02631400

**Kit per tappi olio**

- Bussole magnetiche.
- 1 chiave snodata con coppetta.
- 2 inserti
- 6 inserti
- 6 bussole
- 1 inserto

○ 8-10 mm.

○ 8-10-12-13-14-17 mm.

● 13-14-17-18-19-21 mm.

○ T45.

~~€ 190,00~~

**€ 133,00**

Attacco per il recuperatore d'olio

16  
PEZZI

3/8"



Vaschetta raccogli olio integrata



**870 C**

U08700006

**Pinza per raccordi rapidi carburante**

- Per veicoli a benzina e diesel.
- Impugnature ergonomiche bimalteriali.

~~€ 65,50~~

**€ 46,00**



22  
PEZZI

**1881 S22**

U18810082

**Kit universale per lo smontaggio e il montaggio delle ghiera pulegge alternatori**

- Fornito in cassetta di plastica

~~€ 139,00~~

**€ 97,00**





MAX  
600  
GRADI

2000  
WATT

## 2 MODALITÀ:

- 1 250 l/min - 50°÷400°C
- 2 500 l/min - 50°÷600°C

391

U03910001

### Pistola termica digitale

- Modello elettronico con controllo della temperatura e del volume d'aria mediante display digitale.
- Possibilità di impostazione dei programmi.
- Dotata di sistema di raffreddamento.

~~€ 214,00~~

**€ 93,00**



Accessori inclusi

5  
PEZZI

Per la rimozione di modanature, pioli, parti di cruscotto, rivestimenti portiere, etc.



426 B/S5

U04260006

### Kit di 5 utensili per componenti in plastica

~~€ 32,10~~

**€ 22,50**

4  
PEZZI

Per separare i carter della cinghia di distribuzione, testata motore, cinghia di trasmissione etc.



426 D/S4

U04260005

### Kit di 4 scalpelli separatori in plastica

~~€ 27,50~~

**€ 19,20**



### CARATTERISTICHE TECNICHE

Attacco filettatura	M18
Livello sonoro	78 Db
Lunghezza totale	610 mm
Peso	4 Kg
Pressione di esercizio	6,2 bar
Attacco filettato	1/4"

400 P

U04000010

### Aspiratore pneumatico ammaccature

- Ideale per eliminare ammaccature da parti scatolate senza la necessità di riverniciare.
- Fornito con 3 ventose (Ø 75-100-125 mm), in valigetta in materiale plastico dotata di maniglia per il trasporto e clip di chiusura.

~~€ 206,00~~

**€ 144,00**

4  
PEZZI

Per la rimozione di contrappesi, silicone, modanature etc



426 C/S4

U04260007

### Kit di 4 raschietti multiuso in plastica

~~€ 34,20~~

**€ 24,00**

2  
PEZZI

115 CL/SE2

U01150022

### Serie di 2 pinze lunghe becchi diritti e piegati a 45°

- Ideale per la presa di pezzi e parti in posizioni di difficile accesso.

~~€ 81,50~~

**€ 57,00**



Serraggi controllati utilizzando cricchetti o chiavi a T

1/2"



YouTube

## 814 A

### Dispositivo digitale coppia-angolo

- Permette serraggi coppia ed angolo di precisione digitale anche con utensili tradizionali.
- Per serraggi destrorsi e sinistrorsi.
- Scala di lettura in Nm/ft.lb/in.lb/kg.cm/gradi.
- Doppia indicazione: luminosa (LED) e sonora (buzzer) al raggiungimento del valore impostato.
- 9 valori di coppia o angolo preimpostabili.
- 50 misurazioni memorizzabili.
- In custodia di ABS con certificato di taratura.
- Alimentazione: 2 batterie AAA (incluse).

CODICE	CAPACITÀ	1/2"	RISOL.	<del>€</del>	€
U08140003	6,8÷135 Nm	1/2"	0,1	266,00	187,00
U08140004	10÷200 Nm	1/2"	0,1	306,00	214,00
U08140005	17÷340 Nm	1/2"	0,1	372,00	261,00

Misurazione corretta dell'angolo in qualsiasi posizione

PRECISIONE ±2%



YouTube

## 831 A

U08310001

### Goniometro digitale

- Permette serraggi angolari di precisione digitale in totale semplicità.
- Per serraggi destrorsi e sinistrorsi.
- Precisione angolo: +/- 2%.
- Scala: 0÷360°.
- Risoluzione: 0,1°.
- Doppia indicazione: luminosa (LED) e sonora (buzzer) al raggiungimento del valore impostato.
- 9 valori di angolo preimpostabili.
- 50 misurazioni memorizzabili.
- Fornito in custodia di ABS con certificato di taratura.
- Alimentazione: 2 batterie AAA (incluse nella confezione).

~~€193,00~~

€ 126,00

9 PEZZI

Due spazzole metalliche Ø 20mm e 25mm



## 885 F

U08850004

### Kit pulizia iniettori

- Ideale per la pulizia del condotto degli iniettori montati su motori common rail.

~~€173,00~~

€ 121,00

6 PEZZI

1/2"



## 884 C/S6

U08841000

### Serie di 6 chiavi per raccordi tubi iniettori

- Per montaggio/smontaggio dei raccordi tubi iniettori.
- Lunghezza: 98 mm.
- Misure: 12-14-16-17-18-19 mm.

~~€129,00~~

€ 90,50

## ILLUMINAZIONE A LED

1/2"

1.898 Nm 2,2 kg



YouTube

## CARTER IN LEGA DI MAGNESIO



## TOP DI GAMMA

943 PC1 1/2"

U09430001

### Avvitatore ad impulsi in magnesio

#### CARATTERISTICHE TECNICHE

Attacco quadro	1/2"	Pressione aria raccomandata	6,2 bar
Capacità bullone	M20	Pressione sonora	94 ±3 dB(A)
Coppia massima	1.898 Nm	Potenza sonora	105 ±3 dB(A)
Coppia di lavoro	320÷460 Nm	Vibrazioni	6,4 m/s <sup>2</sup>
Impulsi al minuto	1200	Attacco aria	1/4"
Velocità a vuoto	6.500 giri/min	Diametro intorno tubo aria	10 mm
Consumo medio aria	172 l/min	Peso	2,2 kg

~~€ 513,00~~

**€ 352,00**

## IL RIFERIMENTO

929 PC1 1/2"

U09290001

### Avvitatore ad impulsi in magnesio

#### CARATTERISTICHE TECNICHE

Attacco quadro	1/2"	Pressione aria raccomandata	6,2 bar
Capacità bullone	M16	Pressione sonora	93 ±3 dB(A)
Coppia massima	1.600 Nm	Potenza sonora	104 ±3 dB(A)
Coppia di lavoro	280÷440 Nm	Vibrazioni	6,2 m/s <sup>2</sup>
Impulsi al minuto	1.300	Attacco aria	1/4"
Velocità a vuoto	7.000 giri/min	Diametro interno tubo aria	10 mm
Consumo medio aria	172 l/min	Peso	2,0 kg

~~€ 395,00~~

**€ 267,00**

## EXTRA COMPATTO

942 PC3 1/2"

U09420012

### Avvitatore ad impulsi - extra compatto

#### CARATTERISTICHE TECNICHE

Attacco quadro	1/2"	Pressione aria raccomandata	6,2 bar
Capacità bullone	M16	Pressione sonora	91,1±3 dB(A)
Coppia massima	861 Nm	Potenza sonora	108,1±3 dB(A)
Coppia di lavoro	150÷220 Nm	Vibrazioni	9,57 m/s <sup>2</sup>
Impulsi al minuto	1650	Attacco aria	1/4"
Velocità a vuoto	10.000 giri/min	Diametro intorno tubo aria	10 mm
Consumo medio aria	127 l/min	Peso	1,3 kg

~~€ 255,00~~

**€ 181,00**

## CARTER IN LEGA DI MAGNESIO

1/2"

1.600 Nm 2 kg



YouTube



11 cm



1/2"

861 Nm 1,3 kg



YouTube

YouTube



**Modulare con i cassetti dei carrelli USAG**



**Modulare con i cassetti dei carrelli USAG**



**Modulare con i cassetti dei carrelli USAG**

## 943 PC1/C12 U09430005

415  
92  
mm 283

1/2"

**Assortimento in cassetta modulare con avvitatore ad impulsi e bussole macchina**

12  
PEZZI

DESCRIZIONE	ART./MISURA	PZ.
Avvitatore ad impulsi in magnesio	943 PC1 1/2	1
Chiavi a bussola macchina con bocca esagonale	235 1/2 M/ 10-13-17-18-19-22-24-27-30-32 mm	10
Spina di tenuta	235 MCA/4-6	2
Anello di sicurezza	235 MDA/4-6	2
Prolunghe macchina	236 1/2 M/125	1

€ 688,00

**€ 427,00**

## 929 PC1/C12 U09290005

415  
92  
mm 283

1/2"

**Assortimento in cassetta modulare con avvitatore ad impulsi e bussole macchina**

12  
PEZZI

DESCRIZIONE	ART./MISURA	PZ.
Avvitatore ad impulsi in magnesio	929 PC1 1/2	1
Chiavi a bussola macchina con bocca esagonale	235 1/2 M/ 10-13-17-18-19-22-24-27-30-32 mm	10
Spina di tenuta	235 MCA/4-6	2
Anello di sicurezza	235 MDA/4-6	2
Prolunghe macchina	236 1/2 M/125	1

€ 570,00

**€ 348,00**

## 942 PC3/C7 U09420015

375  
80  
mm 186

1/2"

**Assortimento in cassetta modulare con avvitatore ad impulsi e bussole macchina**

7  
PEZZI

DESCRIZIONE	ART./MISURA	PZ.
Avvitatore ad impulsi - extra compatto	942 PC3 1/2	1
Chiavi a bussola macchina con bocca esagonale	235 1/2 M/ 13-17-19-21-22-24 mm	6
Spina di tenuta	235 MCA/4	1
Anello di sicurezza	235 MDA/4	1

€ 341,00

**€ 232,00**

## ILLUMINAZIONE A LED

## CARTER IN LEGA DI MAGNESIO

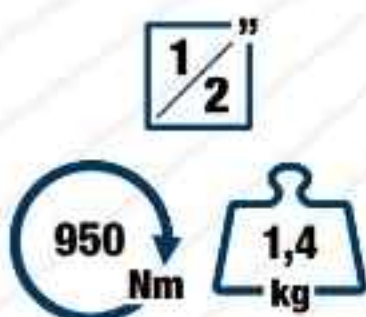

### 943 PC2 1/2"

U09430002

Avvitatore ad impulsi in magnesio con LED - Extra compatto

#### CARATTERISTICHE TECNICHE

Attacco quadro	1/2"	Pressione aria raccomandata	6,2 bar
Capacità bullone	M16	Pressione sonora	95±3 dB(A)
Coppia massima	950 Nm	Potenza sonora	107±3 dB(A)
Coppia di lavoro	200÷270 Nm	Vibrazioni	3,9 m/s <sup>2</sup>
Impulsi al minuto	1400	Attacco aria	1/4"
Velocità a vuoto	10.000 giri/min	Diametro interno tubo aria	10 mm
Consumo medio aria	167 l/min	Peso	1,4 kg

~~€ 437,00~~

**€ 306,00**

## CORPO IN ALLUMINIO



### 928 AC1 1/2"

U09280014

Avvitatore ad impulsi in alluminio

#### CARATTERISTICHE TECNICHE

Attacco quadro	1/2"	Pressione aria raccomandata	6,2 bar
Capacità bullone	M16	Pressione sonora	90 ±3 dB(A)
Coppia massima	1.490 Nm	Potenza sonora	101 ±3 dB(A)
Coppia di lavoro	135 - 380 Nm	Vibrazioni	5,2 m/s <sup>2</sup>
Impulsi al minuto	1.120	Attacco aria	1/4"
Velocità a vuoto	6.500 giri/min	Diametro interno tubo aria	10 mm
Consumo medio aria	147 l/min	Peso	2,8 kg

~~€ 313,00~~

**€ 213,00**

## CARTER IN LEGA DI TITANIO

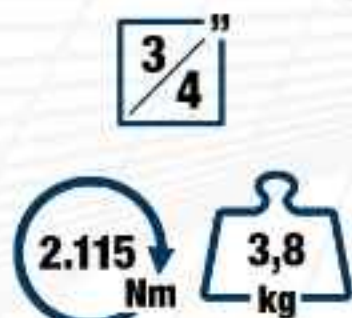

### 942 PD1 3/4"

U09420004

Avvitatore ad impulsi in titanio

#### CARATTERISTICHE TECNICHE

Attacco quadro	3/4"	Pressione aria raccomandata	6,2 bar
Capacità bullone	M27	Pressione sonora	97,8±3 dB(A)
Coppia massima	2.115 Nm	Potenza sonora	108,8±3 dB(A)
Coppia di lavoro	500 - 800 Nm	Vibrazioni	5,06 m/s <sup>2</sup>
Impulsi al minuto	950	Attacco aria	3/8"
Velocità a vuoto	5.300 giri/min	Diametro interno tubo aria	10 mm
Consumo medio aria	200 l/min	Peso	3,8 kg

~~€ 916,00~~

**€ 641,00**

## CORPO IN ALLUMINIO

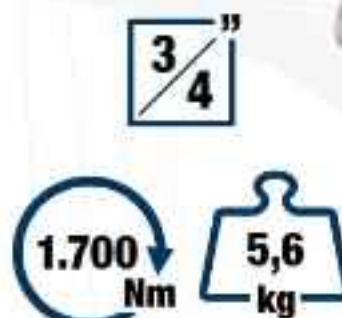

### 928 D1 3/4"

U09280015

Avvitatore ad impulsi in alluminio

#### CARATTERISTICHE TECNICHE

Attacco quadro	3/4"	Pressione aria raccomandata	6,2 bar
Capacità bullone	M24	Pressione sonora	98,4±3 dB(A)
Coppia massima	1.700 Nm	Potenza sonora	109,4±3 dB(A)
Coppia di lavoro	500÷1.050 Nm	Vibrazioni	9,1 m/s <sup>2</sup>
Impulsi al minuto	790	Attacco aria	3/8"
Velocità a vuoto	5.700 giri/min	Diametro interno tubo aria	13 mm
Consumo medio aria	193 l/min	Peso	5,6 kg

~~€ 834,00~~

**€ 584,00**

## CORPO IN COMPOSITO

MANIGLIA  
ERGONOMICA  
BIMATERIALE



**LEGGERO E  
POTENTE**  
- 20% di peso  
rispetto allo standard



**942 PE1 1"**  
U09420005

Avvitatore ad impulsi in materiale composito

CARATTERISTICHE TECNICHE	
Attacco quadro	1"
Capacità bullone	M38
Coppia massima	3.390 Nm
Coppia di lavoro	203±1.627 Nm
Impulsi al minuto	900
Velocità a vuoto	5.000 giri/min
Consumo medio aria	400 l/min
Pressione aria raccomandata	6,2 bar
Pressione sonora	100,9 ±3 dB(A)
Potenza sonora	111,9 ±3 dB(A)
Vibrazioni	10,6 m/s <sup>2</sup>
Attacco aria	1/2"
Diametro interno tubo aria	19 mm
Peso	6,8 kg

~~€ 1.118,00~~

**€ 783,00**

**910 E1 1"**  
U09100020

Avvitatore ad impulsi in alluminio

CARATTERISTICHE TECNICHE	
Attacco quadro	1"
Capacità bullone	M33
Coppia massima	4.068 Nm
Coppia di lavoro	850±1.300 Nm
Impulsi al minuto	720
Velocità a vuoto	4.500 giri/min
Consumo medio aria	243 l/min
Pressione aria raccomandata	6,2 bar
Pressione sonora	102 ±3 dB(A)
Potenza sonora	113 ±3 dB(A)
Vibrazioni	15,2 m/s <sup>2</sup>
Attacco aria	1/2"
Diametro interno tubo aria	13 mm
Peso	10,3 kg

~~€ 1.502,00~~

**€ 999,00**

## CORPO IN ALLUMINIO



152 mm

5 mm

105 l/min

COMPATTA

221 mm



920 AN1  
U09200011

### Levigliatrice roto-orbitale

#### CARATTERISTICHE TECNICHE

Potenza	0,19 Kw
Capacità disco	Ø 152 mm
Orbita	5 mm
Orbite al minuto	10.000 giri/min
Consumo medio aria	105 l/min
Pressione aria raccomandata	6,2 bar
Pressione sonora	78,9±3 dB(A)
Potenza sonora	79,9±3 dB(A)
Vibrazioni	11,8 m/s <sup>2</sup>
Attacco aria	1/4"
Diametro interno tubo aria	10 mm
Peso	0,8 kg



~~€ 332,00~~

**€ 232,00**



125 mm

750 W

12.000  
Giri/min

921 A4  
U09210012

### Smerigliatrice angolare

#### CARATTERISTICHE TECNICHE

Diametro disco	Ø 125 mm
Diametro attacco disco	Ø 24 mm
Potenza	0,75 Kw
Velocità a vuoto	12.000 giri/min
Consumo medio aria	120 l/min
Pressione aria raccomandata	6,2 bar
Pressione sonora	86±3 dB(A)
Potenza sonora	94±3 dB(A)
Vibrazioni	2,5 m/s <sup>2</sup>
Attacco aria	1/4"
Peso	1,9 Kg



~~€ 332,00~~

**€ 232,00**

1/2"

136 Nm

1,2 kg

260 mm



913 PC2 1/2"  
U09130017

### Cricchetto in materiale composito

#### CARATTERISTICHE TECNICHE

Attacco quadro	1/2"	Pressione sonora	99±3 dB(A)
Capacità bullone	M10	Potenza sonora	110±3 dB(A)
Coppia massima	136 Nm	Vibrazioni	9,1 m/s <sup>2</sup>
Velocità a vuoto	280 giri/min	Attacco aria	1/4"
Consumo medio aria	113 l/min	Diametro interno tubo aria	10 mm
Pressione aria raccomandata	6,2 bar	Peso	1,2 kg

~~€ 249,00~~

**€ 175,00**

CAVO 16 m  
Ø 10 mm

939 C1  
U09390004

### Avvolgitubo aria

#### CARATTERISTICHE TECNICHE

Lunghezza tubo	16 m
Diametro interno tubo	10 mm
Pressione max di utilizzo	15 bar
Raccordo in uscita	3/8"
Dimensioni (inclusa staffa)	450x400x230 mm
Peso	8 kg



~~€ 331,00~~

**€ 232,00**



## GAMMA SMERIGLIATRICI PNEUMATICHE



YouTube

30.000 Giri/min

0,3 CV  
220 W



922 B1  
U09220001

Smerigliatrice dritta

### CARATTERISTICHE TECNICHE

Consumo medio aria	76 l/min	Vibrazioni	2,42 m/s <sup>2</sup>
Pressione aria raccomandata	6,2 bar	Attacco aria	1/4"
Pressione sonora	84,8±3 dB(A)	Diametro interno tubo aria	10 mm
Potenza sonora	99,5±3 dB(A)	Peso	440 g

~~€ 116,00~~

**€ 69,00**

23.000 Giri/min

0,3 CV  
220 W



922 BP1  
U09220004

Smerigliatrice angolare 90°

### CARATTERISTICHE TECNICHE

Consumo medio aria	76 l/min	Vibrazioni	4,54 m/s <sup>2</sup>
Pressione aria raccomandata	6,2 bar	Attacco aria	1/4"
Pressione sonora	85,9±3 dB(A)	Diametro interno tubo aria	10 mm
Potenza sonora	96,9±3 dB(A)	Peso	555 g

~~€ 165,00~~

**€ 115,00**

28.000 Giri/min

0,3 CV  
220 W



922 BL1  
U09220003

Smerigliatrice mandrino lungo

### CARATTERISTICHE TECNICHE

Consumo medio aria	76 l/min	Vibrazioni	2,86 m/s <sup>2</sup>
Pressione aria raccomandata	6,2 bar	Attacco aria	1/4"
Pressione sonora	83,3±3 dB(A)	Diametro interno tubo aria	10 mm
Potenza sonora	94,3±3 dB(A)	Peso	664 g

~~€ 165,00~~

**€ 115,00**



**16**  
PEZZI

**1/2"**

**1/2"** **5/16"**

mm  $\rightarrow$  210  
 $\downarrow$  60  
 $\nearrow$  130

## 687 1/2" C16

U06870100



**Assortimento in cassetta di ABS con inserti macchina**

DESCRIZIONE	ART./MISURA	PZ.
Portainseri	685 6 1/2	1
Portainseri	685 8 5/16	1
Inserti esagono maschio 1/2	687 E 6-7-8-10-12-14	6
Inserti TORX 1/2	687 TX T30 T40 T45 T50 T55	5
Inserti PHIL. LIPS 5/16	686 PH 2-3-4	3

~~€ 197,00~~

**€ 106,00**



**16**  
PEZZI

**1/2"**

mm  $\rightarrow$  375  
 $\downarrow$  80  
 $\nearrow$  186

## 235 1/2" M/C16

U02359285



**Assortimento in cassetta modulare con bussole macchina esagonali**

DESCRIZIONE	ART./MISURA	PZ.
Chiavi a bussola macchina con bocca esagonale	235 1/2 M 10-12-13-14-15-16-17-18-19-21-22-24-27-30-32 mm	15
Spina di tenuta	235 MCA/4-6	2
Anello di sicurezza	235 MDA/4-6	2
Prolungha macchina	236 1/2 M/125	1

~~€ 234,00~~

**€ 117,00**



**6**  
PEZZI

**3/4"** **7/8"**

mm  $\rightarrow$  210  
 $\downarrow$  60  
 $\nearrow$  130

## 688 3/4" MD6

U06880010



**Assortimento in cassetta di ABS con inserti macchina**

DESCRIZIONE	ART./MISURA	PZ.
Portainseri	685 B1 7/8	1
Inserti esagono maschio 7/8	688 E 12-17-19-22-24	5

~~€ 232,00~~

**€ 159,00**



**8**  
PEZZI

**3/4"**

mm  $\rightarrow$  375  
 $\downarrow$  80  
 $\nearrow$  186

## 235 3/4" M/C8

U02359286



**Assortimento in cassetta modulare con bussole macchina esagonali**

DESCRIZIONE	ART./MISURA	PZ.
Chiavi a bussola macchina con bocca esagonale	235 3/4" M 21-22-24-27-30-32-36-41 mm	8

~~€ 240,00~~

**€ 127,00**

# BUSSOLE MACCHINA RIBASSATE 235 MB



1/2" **10**  
PEZZI

→ 190  
↓ 58  
mm ↗ 144



1/2"

1/2"

**22**  
PEZZI

→ 415  
↓ 92  
mm ↗ 283

235 1/2" MB/C10  
U02350530

Assortimento in cassetta modulare con  
bussole macchina esagonali ribassate

DESCRIZIONE	ART./MISURA	PZ.
Chiavi a bussole macchina ribassate esagonali	235 1/2" M 10 11 12 13 14 15 16 17 18 19	10

~~€ 91,50~~

**€ 59,00**

236 KE/C22  
U02360900



Assortimento in cassetta modulare con bussole macchina  
esagonali ribassate, prolunga a catena, inserti e accessori

DESCRIZIONE	ART./MISURA	PZ.
Chiavi a bussole macchina ribassate esagonali	235 1/2" MB 10-14-15-16-17-18-19	7
Prolunga a catena	236 KE 1/2"	1
Inserti macchina esagonali	687 E S 6 B 10 12-14	6
Inserti macchina TORX	687 TX T25 T27 T30 T40 T45 T50 T55	7
Adattatore per bussole	236 KEADP	1

~~€ 387,00~~

**€ 199,00**

UTILIZZABILI CON  
AVVITATORE AD IMPULSI

236 K  
per bussole



YouTube



MASSIMA ACCESSIBILITÀ  
DIMENSIONI TESTA COME UN  
CRICCHETTO\*.



**39 mm**

\*Confronto con cricchetto da 1/2".

236 K

1/2" 1/4"

Prolunga a catena in alluminio per bussole

CODICE	☑	L	H	🛒	
U02360700	1/2"	340 mm	39 mm	1,1 kg	<del>€ 118,00</del> <b>€ 59,00</b>
U02360698	1/4"	260 mm	27 mm	300 g	<del>€ 89,00</del> <b>€ 49,00</b>

236 KE  
per inserti



YouTube

MINIMO INGOMBRO  
INNESTO DIRETTO PER  
INSERTI MACCHINA.



Anello di tenuta  
in acciaio integrato.

236 KE

1/2" 1/2" 1/4" 1/4"

Prolunga a catena in alluminio per inserti

CODICE	☑	🔗	L	H	🛒	
U02360705	1/2"	1/2"	340 mm	24 mm	1,1 kg	<del>€ 118,00</del> <b>€ 59,00</b>
U02360710	1/4"	1/4"	260 mm	19 mm	300 g	<del>€ 89,00</del> <b>€ 49,00</b>



**Iscriviti  
al nostro canale**

**@USAGitalia**

Video tutorial,  
novità di prodotto  
e molto altro!



**Sei un utilizzatore finale e vuoi contattarci?**

Vai sul nostro sito:



**[usag.it/it/contacts/support](https://usag.it/it/contacts/support)**



Oppure chiamaci: tel. 02.8295.3731 da Lunedì a Venerdì dalle 08:30 alle 19:30.

**Offerta valida fino al 31 gennaio 2025 salvo esaurimento scorte, presso i Rivenditori che aderiscono all'iniziativa.**

Tutti i prezzi sono da intendersi in Euro, IVA esclusa. Le immagini riprodotte in questa brochure sono indicative. Stanley Black & Decker Italia S.r.l. si riserva in ogni momento di modificare le caratteristiche tecniche dei prodotti.



**Stanley Black & Decker Italia S.r.l.**

Sede operativa:

Via Volta, 3 - 21020 - Monvalle (VA)

Tel. +39 0332 790 111 - [info.mv@usag.it](mailto:info.mv@usag.it)

**usag.it**

